

**STERIL**

A FOSTER  WHEELER COMPANY

# VBH COMPACT

*Class 2- Biohazard Safety Cabinet  
with automatic control system*

**MICROPROCESSOR BASED**

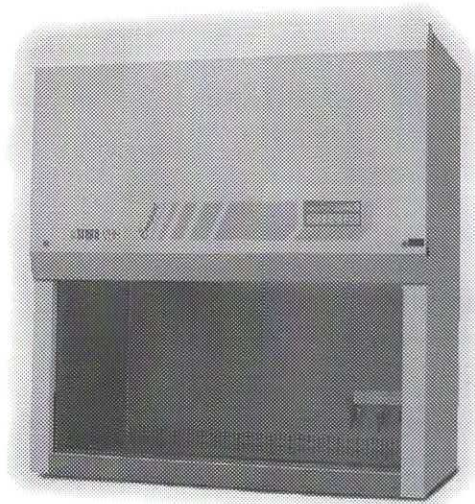

**USER MANUAL**



**ME-2880c**  
October 2002 Issue

**GENERAL INDEX**

|                                  |          |
|----------------------------------|----------|
| <b>GENERAL INDEX</b> .....       | <b>2</b> |
| <b>USE OF THE MANUAL</b> .....   | <b>4</b> |
| <b>INTRODUCTORY LETTER</b> ..... | <b>4</b> |

**PART ONE**

|                                                           |           |
|-----------------------------------------------------------|-----------|
| <b>1. GENERAL SAFETY GUIDELINES</b> .....                 | <b>7</b>  |
| <b>2. INSTALLATION, MOVEMENT AND TRANSPORTATION</b> ..... | <b>9</b>  |
| 2.1 CONNECTION TO UTILITY FLUIDS.....                     | 13        |
| 2.2 CONVEYING OF THE EXHAUST AIR.....                     | 14        |
| <b>3. MAIN TECHNICAL DETAILS</b> .....                    | <b>15</b> |
| <b>4. OPERATING PRINCIPLE</b> .....                       | <b>17</b> |
| <b>5. FUNCTIONS</b> .....                                 | <b>19</b> |
| 5.1 TO START THE CABINET.....                             | 19        |
| 5.2 CONTROL PANEL.....                                    | 20        |
| 5.3 ELECTRONIC BOARD INSTRUCTIONS.....                    | 21        |
| 5.3.1 Mode I: User (protection mode).....                 | 21        |
| 5.3.2 Mode II User.....                                   | 22        |
| 5.3.3 Client Service Mode.....                            | 23        |
| 5.3.4 ALARMS:.....                                        | 24        |
| 5.4 PRECAUTIONS DURING OPERATION.....                     | 25        |
| 5.5 ALARMS.....                                           | 26        |
| <b>6. AVAILABLE UTILITIES</b> .....                       | <b>27</b> |
| 6.2 TRANSPARENT FRONT SCREEN.....                         | 27        |
| 6.2 ILLUMINATION.....                                     | 27        |
| 6.3 UV GERMICIDAL LAMP.....                               | 27        |
| 6.3.1 UV timer.....                                       | 28        |
| 6.4 FUEL GAS FOR BUNSEN BURNER.....                       | 29        |
| 6.5 VACUUM, COMPRESSED AIR, INERT GAS.....                | 29        |
| 6.6 POWER SOCKET.....                                     | 29        |
| <b>7. DRAWINGS</b> .....                                  | <b>30</b> |
| <b>8. OPERATIONS CARD</b> .....                           | <b>35</b> |

**PART TWO**

|                                                           |           |
|-----------------------------------------------------------|-----------|
| <b>9. GENERAL FEATURES</b> .....                          | <b>37</b> |
| <b>10. SPARE PART REQUESTS</b> .....                      | <b>38</b> |
| <b>11. ORDINARY AND PREVENTIVE MAINTENANCE</b> .....      | <b>38</b> |
| <b>12. SAFETY SPECIFICATIONS DURING MAINTENANCE</b> ..... | <b>38</b> |
| <b>13. PERIODICAL CLEANING</b> .....                      | <b>39</b> |

|                                                                    |           |
|--------------------------------------------------------------------|-----------|
| <b>14. TABLE OF ORDINARY PERIODIC MAINTENANCE.....</b>             | <b>40</b> |
| <b>15. TABLE OF PERIODIC CONTROLS.....</b>                         | <b>41</b> |
| <b>16. PROBLEM SOLVING TABLE (DEFECTS RESEARCH).....</b>           | <b>42</b> |
| <b>17. MAINTENANCE (REPLACEMENT OF PARTS SUBJECT TO WEAR).....</b> | <b>43</b> |
| 17.1 REPLACEMENT OF THE FLUORESCENT LAMPS .....                    | 43        |
| 17.2 REPLACEMENT OF THE UV GERMICIDAL LAMP.....                    | 44        |
| 17.3 REPLACEMENT OF THE HEPA FILTER .....                          | 45        |
| <b>18 CONTROLS - TESTING.....</b>                                  | <b>47</b> |
| 18.1 INSTALLATION TESTING - .....                                  | 47        |
| 18.2 ROUTINE MAINTENANCE TESTING .....                             | 47        |
| <b>19. FUMIGATION/DECONTAMINATION PROCEDURE.....</b>               | <b>49</b> |
| 19.1 GENERAL FEATURES OF DECONTAMINATION.....                      | 49        |
| 19.2 EXECUTION OF THE STANDARD PROCEDURE.....                      | 51        |
| <b>20. LIST OF SPARE PARTS .....</b>                               | <b>53</b> |
| <b>21. ELECTRIC DIAGRAM .....</b>                                  | <b>55</b> |
| <b>22. GLOSSARY .....</b>                                          | <b>57</b> |
| <b>23. CABINET ACCESSORIES .....</b>                               | <b>58</b> |
| <b>24. ATTACHMENTS.....</b>                                        | <b>58</b> |
| 24.1 ATTACHED UNDER SEPARATE COVER TO THE PRESENT MANUAL.....      | 58        |
| <b>25. INDICE ALLEGATI PER MODIFICA E/O ERRATA-CORRIGE.....</b>    | <b>59</b> |



## USE OF THE MANUAL

The User Manual is the document that accompanies the cabinet from the time of its construction to the time of its demolition.

It is in fact an integral part of the equipment.

The Manual should be read carefully before performing any sort of activity that involves the equipment, including its movement and transportation.

For easy reference the Manual is divided into paragraphs.

**IMPORTANT:** THE CONSTRUCTOR DISREGARDS ANY CIVIL & PENAL RESPONSIBILITY WHATSOEVER, IN CASE OF ABUSE, ERRORS AND INCORRECT OPERATIONS AND IN GENERAL, FOR ANY OPERATIONS INVOLVING THAT ARE NOT ALLOWED OR NOT IN LINE WITH THE PROCEDURES PRESCRIBED BY THIS USER MANUAL.

## INTRODUCTORY LETTER

The present Manual is an integral part of the cabinet and must therefore always be available for the operator's reference.

The operator and the person in charge of the cabinet's maintenance are obliged to be informed on the contents of this manual.

The description and illustrations contained in this Manual are not to be considered as binding.

Nevertheless, even though the essential characteristics of this equipment will remain as described, **STERIL S.p.A.** reserves the right to modify components or optional items at any time, without updating this publication, if said modifications are retained to improve the product for commercial or constructive reasons.

**ALL RIGHTS ARE RESERVED**, the reproduction of this manual in any of its parts is strictly forbidden, without written authorisation from **STERIL S.p.A.**.

The contents of this manual may be modified without prior notice. The documentation contained in this manual has been collected and verified with great care, for it to be as complete and comprehensible as possible.

### **IMPORTANT!!**

*The cabinets we produce, according to the above statements, are manufactured in compliance with the laws on safety into force.*

*Particularly, they are manufactured in compliance with Art. 6 Dlgs 626/94 and its modification (Italian law in compliance with European Directive EEC/89/391) on the DUTY OF DESIGNERS, OF MANUFACTURERS, OF SUPPLIERS AND INSTALLATORS.*

*The cabinets are NOT submitted to the directive EEC 93/42 on Medical Devices, as indicated in the definition of "Medical Devices" reported in art. 1 point 2a of the Directive mentioned.*

*STERIL S.p.A. IS NOT responsible for damages to people and objects due to a non-proper use of the cabinet, and due to a fail to comply with the user instructions and maintenance that are always supplied with the cabinets.*

**Guidelines & Standards of Reference**

The following GUIDELINES and construction standards have been considered during the design of this cabinet :

- ⇒ EN 12469: Performance criteria for microbiological safety cabinets.
- ⇒ EN 61010-1 Safety prescriptions for electronic measuring, control and laboratory equipment - General prescriptions
- ⇒ EN 292-1: Equipment Safety - Main concepts, terminology, basic methodology.
- ⇒ EN 292-2 : Equipment Safety - Main concepts - Technical specifications and principles.
- ⇒ Machinery Directive 89/392/CEE - 91/368/CEE - 93/44/CEE - 93/68/CEE (as applicable).
- ⇒ Electromagnetic Compatibility Directive 89/336/CEE - 92/31/CEE - 93/68/CEE
- ⇒ Low Voltage Directive 73/23/CEE - 93/68/CEE.

The cabinets **ARE NOT** designed to operate in explosion/fire risk environments or in tropical thermo-hygrometric conditions.

Please contact the **STERIL S.p.A.** after sales assistance dept. to request information or should any problems arise.

**AFTER SALES TECHNICAL ASSISTANCE  
STERIL S.p.A.  
Via A. Grandi, 16  
20017 Mazzo di Rho - (MI) - ITALY  
Tel. +39.02.939.701.20  
Fax +39.02.939.701.21**



**The original configuration of the equipment must not be modified**

Upon receipt of the equipment check the following:

- that the packaging is integral and has not been damaged.
- that the supply corresponds to the specifications of the order.

In case of damage inform **STERIL S.p.A.** immediately.

The drawings and any other document delivered are the sole property of **STERIL S.p.A.**, that reserves all rights. They cannot be handed to third parties.

**PART ONE**



## 1. GENERAL SAFETY GUIDELINES



### BEWARE

BEFORE STARTING THE CABINET READ THE INSTRUCTIONS CONTAINED IN THIS MANUAL CAREFULLY.

**IMPORTANT:** THE CONSTRUCTOR DISREGARDS ANY CIVIL & PENAL RESPONSIBILITY WHATSOEVER, IN CASE OF ABUSE, ERRORS AND INCORRECT OPERATIONS AND IN GENERAL, FOR ANY OPERATIONS THAT ARE NOT ALLOWED OR NOT IN LINE WITH THE PROCEDURES PRESCRIBED BY THIS USER MANUAL.

The equipment consists in a microbiological safety cabinet, i.e. a vertical laminar class 2 airflow unit, designed according to European Standard EN 12469, German standards DIN 12950 TEIL 10, French standards NFX 44-201 and English standards BS 5726, that ensures the protection of the operator, product and environment during the manipulation of biologically active or infectious substances, as defined in the appropriate standards, against risks deriving from potentially contaminated aerosols during microbiological and biotechnological operations, with the exception of radioactive, toxic and corrosive substances.

The "I", "II", "O" buttons and the access password define the cabinet's functions. Only authorised and trained personnel should know the cabinet password (see dedicated paragraph). Only mode "I", when no alarm is sounding, guarantees the protection of the operator and environment (biologic safety condition as described above).

The operators must be warned that SUCH WORK CONDITION IS NOT GUARANTEED WHEN CABINET IS IN MODE "II" or "O" (cabinet switched off).

**NOTE:** Microbiological Safety Cabinets are designed to reduce the risks an operator runs into during the manipulation of biologically active or infectious substances, but they do not necessarily protect from all the other risks involved in said activity, if the operator is not properly trained and does not carefully follow the appropriate techniques.

The microbiological, vertical laminar flow, class 2 safety cabinet also protects the material been manipulated against environmental contamination and cross-contamination.

The use of a safety cabinet depends on the type of material and micro-organisms that have to be examined and treated. Therefore the cabinet cannot be used correctly if the above mentioned pathogen materials have not been taken into consideration prior to their manipulation.

For example, one could refer to the DPAG (Dangerous Pathogens Advisor Group) of the English DHSS (Department of Health and Social Security), to the U.S. DEPARTMENT OF HEALTH EDUCATION AND WELFARE CENTRE FOR DISEASE CONTROL or to the NATIONAL CANCER INSTITUTE (NCI), U.S.A. OR TO FRENCH NFX 44-201.

In Italy, the law decree D.L. 626/94 (updated by the D.L. 242/96, in compliance with the European Directive EEC/89/391 "Safety and health of workers on pleace of work") reports the classification of biologic agents (title VIII-art.75 and relative attachment XI) and specifically covers argumentations like measures of containment and levels of containment based on the nature of the foreseen activities, considered during the evaluation of the risk (attachment XII).

**NOTE:** please refer to the laws, standards and regulations in force in the country of the end-user or eventual documents of reference, in order to be able to classify all pathogen agents.

The Microbiological Safety Cabinet is therefore to be considered as a primary protection barrier.



Whenever an alarm sounds the microbiological safety conditions are NO longer guaranteed and therefore, the operations been performed in that very instant should be immediately interrupted. The dangerous material, that is been manipulated, must be placed into safety (air tight) containers, locked into the cabinet by closing the front access window and immediate authorised technical assistance must be requested.

Do not use the cabinet until authorised technical assistance has intervened.

The laboratory should have an emergency plan and procedures containing precise indications on the procedures to follow in case of bio-risk.

The alarms verify the aeraulic conditions of the cabinet during normal functioning conditions, **biological safety conditions might not be guaranteed for accidental reasons** (for example, damage of the cabinet's structure or damage of the HEPA filters). Such conditions are not alerted by the alarm.

For the above reason it is imperative that a periodic control test be done, (see dedicated paragraph), at the prescribed interval.

**STERIL S.p.A. advises to run the tests every six months and in any case, the test is compulsory once a year.**

**STERIL S.p.A. Biological Safety Cabinets provide maximum knee/thigh clearance which improves the users ability to assume a proper posture. The frameless edge and the improved height of the front window allow for greater visibility and better sight lines to the effective work zone area reducing awkward posture resulting in less eye fatigue and/or neck strain.**

**The proper ergonomically designed laboratory chair (not supplied) should have a star based platform, five casters that lock when occupied, an adjustable back support, an adjustable lumbar support, and be able to move to different height requirements. A footrest is also highly recommended.**

If the equipment is supplied with a germicidal ultra violet ray lamp, carefully read through the paragraph entitled **AVAILABLE UTILITIES** to avoid staff been exposed to UV radiation.

As far as the fuel gas line is concerned, of the BUNSEN burner, carefully read through the paragraph entitled **AVAILABLE UTILITIES** to avoid gas leakage accompanied by fire and explosion risks.

To avoid staff been exposed to formaldehyde vapours, carefully read through the paragraph entitled **DECONTAMINATION**.

As far as packing, transport and movement of the cabinet are concerned, carefully read through the paragraph entitled **INSTALLATION, MOVEMENT AND TRANSPORTATION**.



## 3. MAIN TECHNICAL DETAILS

| MODEL                                                                                                       | VBH CE                         |                                | VBH C2                         |                                |
|-------------------------------------------------------------------------------------------------------------|--------------------------------|--------------------------------|--------------------------------|--------------------------------|
| SIZE                                                                                                        | 48                             | 72                             | 48                             | 72                             |
| <b>Power Feeding:</b>                                                                                       |                                |                                |                                |                                |
| Electrical Classification                                                                                   | Class I with feeding cord      |                                |                                |                                |
| Voltage (V)                                                                                                 | 230 single-phase               |                                |                                |                                |
| Frequency (Hz)                                                                                              | 50                             |                                |                                |                                |
| Absorption (A)<br>(including service power socket 4A on charge)                                             | 8                              | 9.5                            | 9                              | 10                             |
| <b>Service Fluids:</b>                                                                                      |                                |                                |                                |                                |
| Max. air/nitrogen/ compressed CO <sub>2</sub> pressure (bar)                                                | 4                              |                                |                                |                                |
| Max. fuel gas for bunsen (mbar) pressure                                                                    | 20                             |                                |                                |                                |
| <b>Heat transmitted to the environment:</b>                                                                 |                                |                                |                                |                                |
| (with the exclusion of utilities attached to the duty power socket and to the gas distribution line) (Kcal) | 450                            | 520                            | 460                            | 540                            |
| <b>Weight and dimensions:</b>                                                                               |                                |                                |                                |                                |
| General Dimensions                                                                                          | Please refer to drawing 7.1    |                                |                                |                                |
| Dimension of safe work area (lxdxh mm)                                                                      | 1188x500<br>x685 <sup>1)</sup> | 1780x500<br>x685 <sup>1)</sup> | 1188x500<br>x685 <sup>1)</sup> | 1780x500x<br>685 <sup>1)</sup> |
| 1) Total depth is 602mm = 102mm inlet grid (no protection) + 500mm net safe work surface.                   |                                |                                |                                |                                |
| Maximum front aperture height (mm)                                                                          | 470                            |                                | 530                            |                                |
| Net weight (kg)                                                                                             | 200                            | 285                            | 200                            |                                |
| Gross weight with packing (kg)                                                                              | 235ca.                         | 305ca.                         | 235ca.                         | 305ca.                         |
| Gross weight of the supporting stand with packing (kg)                                                      | 20                             | 25                             | 20                             | 25                             |

The data is referred to standard packing material for truck transportation (cardboard on pallets).

### TRANSPORT AND STOCKING CONDITIONS

Environmental temperature (°C): min **-15** / max. **50**;

Relative humidity (%): max. **90**;

Atmospheric pressure (mbar): min **800** / max. **1060**.

**SYSTEM PERFORMANCE**

According to EN 12469:

- retention at front aperture<sup>1)</sup>:  $\leq 5$  CFU per non disturbance test, or  $A_{pf} \geq 1 \times 10^5$ ;
- product protection:  $\leq 5$  CFU per test
- cross contamination:  $\leq 2$  CFU per test

1) Expressed in  $A_{pf}$  or egress of microorganism.

Work space air cleanliness: better than Class ISO 5 according to ISO EN 14644-1 (Class 100/M3.5 according to Federal Standard 209E, Grade A according to European GMP, Annex 1 at Rest conditions) for 0.3 and 0.5  $\mu\text{m}$  sized particles.

**GUIDELINES & STANDARDS OF REFERENCE**

The main guidelines and standards of reference in the design of the cabinet are:

**For microbiological safety:**

**EN 12469** – European standard – EU;

**DIN12950 TEIL 10** - Deutsch Institute für Nurmung – D;

**NFX 44-201** and the complimentary specifications contained in the "reglement particulier NF-095" – F;

**NSF 49** - National Sanitation Foundation - USA;

**BS 5726** - British Standard - UK;

**AS2252** - Australian Standard – AUS.

**Electrical power system safety:**

**CEI EN 61010/1 (EN 61010)**

**The equipment has also been constructed in accordance with the following directives:**

- MACHINERY DIRECTIVE 89/392/CEE - 91/368/CEE - 93/44/CEE - 93/68/CEE, (as applicable)
- ELECTRO MAGNETIC COMPATIBILITY 89/336/CEE - 92/31/CEE - 93/68/CEE
- LOW VOLTAGE DIRECTIVE 73/23/CEE - 93/68/CEE

See attached fac-simile of Declaration of Conformity.



## 4. OPERATING PRINCIPLE

VBH COMPACT is a Microbiological class 2 Safety Cabinet (as indicated EN 12469), with partial recycle of filtered air (about 70% of total air volume: "A" with refer to picture below) and partial exhaust of filtered air to the outside (about 30% of total air volume: "B").

The amount of exhausted air ("B") is compensated by an equal amount of air, defined as "barrier protection" ("B"), that is regained by the front opening of the work space.

The correct balancing of the recycle/exhaust airflow, carried out during testing c/o the manufacturer in accordance with current standards, enables the operator and the product to be protected from the environment during the manipulation of biological risk agents, as described in the appropriate standards, in the absence of toxic volatile compositions or radionuclides.

Environment protection is guaranteed by means of the absolute filtration of the exhaust air through the HEPA filter conforming to the requirements of class H14 of EN 1822-1.

The operator's safety is ensured by means of the front air barrier that prevents aerosols from passing through the inside of the cabinet to the outside.

The air velocity of the front barrier is therefore a crucial factor, always to be kept into consideration. Low inlet air velocity will not guarantee the operator's protection by allowing the exit of eventual particles from the cabinet.

The product is protected by means of the ISO Class 5 laminar airflow according to ISO EN 14644 (Class 100/M3.5 according to Federal Standard 209E, Grade A according to European GMP, Annex 1 at Rest conditions) for 0.3, and 0.5 µm sized particles. The air, by means of a main HEPA filter conforming to the requirements of class H14 of EN 1822-1, moves perpendicularly to the work surface in a unidirectional manner (at laminar airflow speed), keeping the work space clean and dust free. The laminar air flow reduces cross contamination risks.

Since the correct balancing of the recycle/exhaust air flow is fundamental to obtain a good protection of the product / operator / environment, the automatic regulation of the ventilating speed rate of the VBH COMPACT microbiological safety cabinet is provided by a microprocessor, that guarantees the maintenance of the values set during testing at the manufactory.

Should the above mentioned balancing be altered, for any reason whatsoever, the alarms installed on the equipment will sound and lighten immediately.

### LEGENDA:

- 1 Ventilator
- 2 Main HEPA filter
- 3 Exhaust HEPA filter

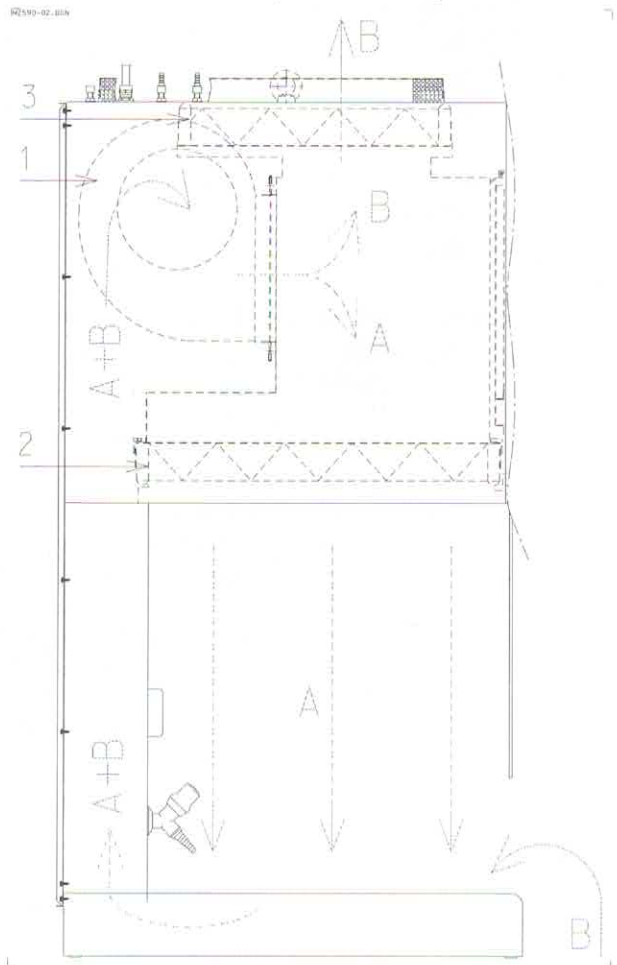

The alarms installed onto the VBH COMPACT cabinet are very selective and even a slight decrease in the air flow is sufficient for them to sound, as the air flow itself is fundamental in the creation of the barrier that protects the operator.

The alarms are visual and acoustic at the same time.

Their intervention, (as foreseen by international standards of reference), does not provoke the halting of the equipment and therefore, they are automatically disconnected once the aeruolic conditions return to normal.

The acoustic alarm is re-activated after one minute if the anomaly persists.

**ATTENTION:** IN CASE THE ALARM GOES ON, OPERATE AS INDICATED IN PAR. 1, GENERAL SAFETY REGULATIONS.

**NOTE :** VBH COMPACT SAFETY CABINETS ARE DESIGNED IN ORDER TO PREVENT ANY EVENTUAL BY-PASS OF CONTAMINATED AIR ON THE MAIN AND EXHAUST HEPA FILTERS.

THIS CONDITION IS GUARANTEED BY THE "DYNAMIC TIGHT" SYSTEM, THAT BY MEANS OF THE NEGATIVE PRESSURE THAT SURROUNDS THE MAIN FILTERS, FORBIDS ANY BLOW-BYS CAUSED BY DEFECTS IN THE PERIPHERAL GASKETING OF THE FILTERS THEMSELVES.

It is advisable, both during the first installation phase and during periodic controlling (yearly), to verify the tightness of the HEPA filter gasketing by means of the DOP/DOS TEST.

For further information, please contact the **STERIL S.p.A.** after sales service.



## 5. FUNCTIONS

### 5.1 TO START THE CABINET

The functioning of the cabinet is defined by the three buttons on the soft touch panel: "O" for cabinet OFF, "I" to start "MODE I" and "II" to start "MODE II". A password allows the use of the cabinet only to authorized personnel.

**Default password is "0000" and "↵" or simply "↵" .**

**Password may be changed following the procedure described in Par. 5.3.2 or 5.3.3.**

### BEWARE BEWARE

**It is imperative to establish univocably who may access the cabinet password.**

**In addition, it is necessary to establish univocably the precise manner to warn unambiguously all operators, that when functioning in "MODE 2", their protection and that of the product been manipulated is no longer guaranteed.**

**MODE I:** Allows the equipment to function normally; the germicidal lamp is disconnected. Press the "I" button and type the password; now, by pressing "↵" button (enter), the ventilation and the acoustic/visual alarms are turned on. After about 30 seconds, as soon as the correct aeraulic speed is reached, the alarms disconnect themselves.

**In version with hinged window**, before starting the ventilation, the front closing panel must be removed. **ALWAYS VERIFY** that the electrical cord of the germicidal lamp has been disconnected and hang it on the appropriate hook on the right side of the cabinet.

**In the version with sliding front window** once the key has been turned to position one, the front screen must be lifted to working level (see dimensional drawing 7.1.1) otherwise the alarm for incorrect positioning will keep sounding. If the screen is completely lowered, ventilation will be inhibited.

**MODE II:** This position turns on the holding procedure of the cabinet which excludes all ventilating functions, alarms and all the devices connected to these functions. Press the "II" button and type the password; now, by pressing "↵" button (enter), the germicidal lamp can be turned on or, as alternative, the fluorescent lamp.

The internal electrical power socket and the sliding function of the front window, in the version with this characteristic, remain available for use.



**BEWARE: MODE II DOES NOT GUARANTEE THE OPERATOR'S PROTECTION.**

**MODE O:** The cabinet is off. However this position cannot be considered as power disconnection therefore, to prevent accidents during maintenance operations, it is **IMPERATIVE** that the cabinet be totally isolated by also disconnecting the power plug from the main electric power feeding source.

Once "O" button has been selected, password typed, by pressing "↵" button (enter) any unauthorised operations will be prevent.

## 5.2 CONTROL PANEL

All functions are controlled by an electronic card with microprocessor .

**The control panel accommodates:**

- 1) Digital display of the cabinet parameters
- 2) Green LED for Power Voltage ON
- 3) Esc key to cancel operation in progress or to exit from an alarm message
- 4) ENTER button to input data
- 5) Mode O (Cabinet OFF)
- 6) Mode I (Ventilation ON)
- 7) Mode II (UV + Service)
- 8) Lighting ON/OFF push-button
- 9) UV lamp ON/OFF push-button
- 10) Socket Outlet ON/OFF push-button
- 11) Fuel gas solenoid valve ON/OFF push-button
- 12) RIGHT/LEFT arrow keys to scroll data
- 13) UP and DOWN arrow keys to increase or decrease data (eg. time) and for the activation of the transparent front screen (version with sliding front window only)
- 14) Red luminous indicator for alarm.

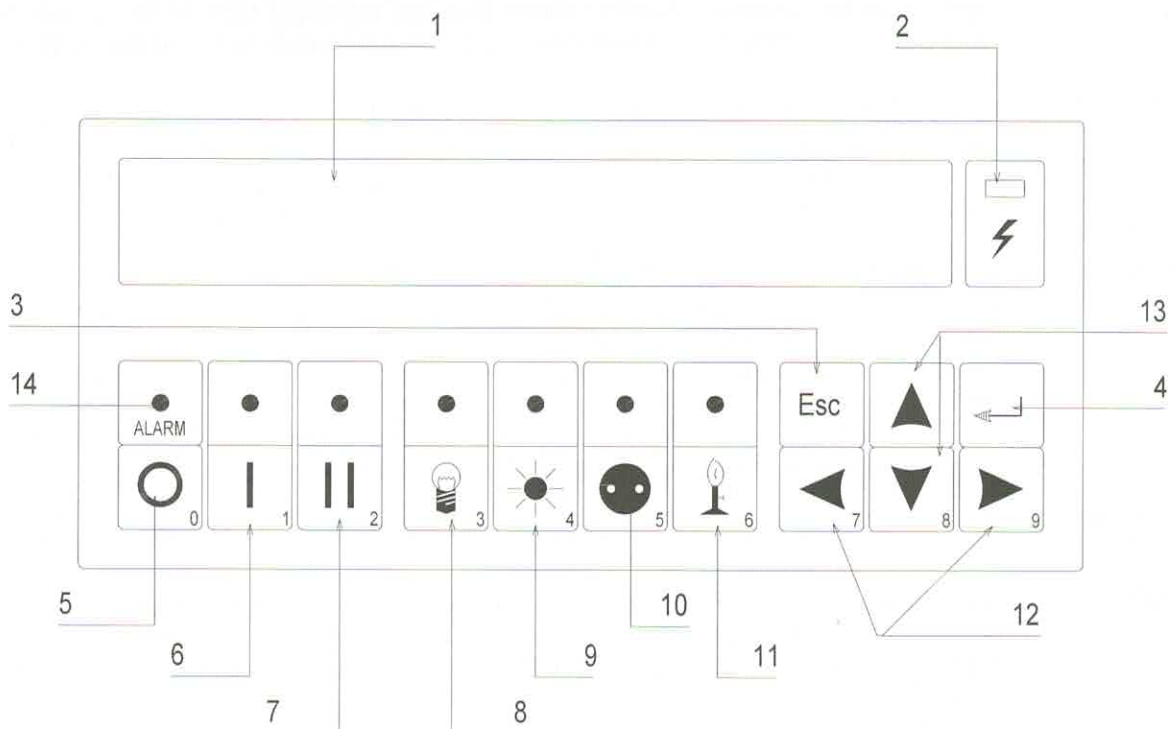



## 5.3 ELECTRONIC BOARD INSTRUCTIONS

During Start Up it will be displayed for 5 seconds:

Software version 3.4

Followed by:

\* POWER FAILURE \*  
 \*\* Press ESC \*\*

Press ESC: Date and Time input request will appear:

Date 01.01.2000  
 Time 00.00

Press ENTER. The MSC is in Stand-By mode.

STAND-BY

Pressing MODE I or MODE II keys password request will be displayed:

Enter  
 Password: \_

### Legenda

↵ = Enter button

◀▶ = Scroll Left or Scroll Right buttons (shows prev./next mask)

⬆⬇ = Up or Down buttons (in/decrease values)

### Note

(1) Present only if "Inlet Filter Fitted" = Yes.

(2) Present only if " Fan Regulation " = Automatic.

(3) Present only if " Fan Regulation " = Manual.

(4) Present only if " Loop Regulation " = Double.

### 5.3.1 Mode I: User (protection mode)

Password: 0 ↵ (to be changed by laboratory responsible person)

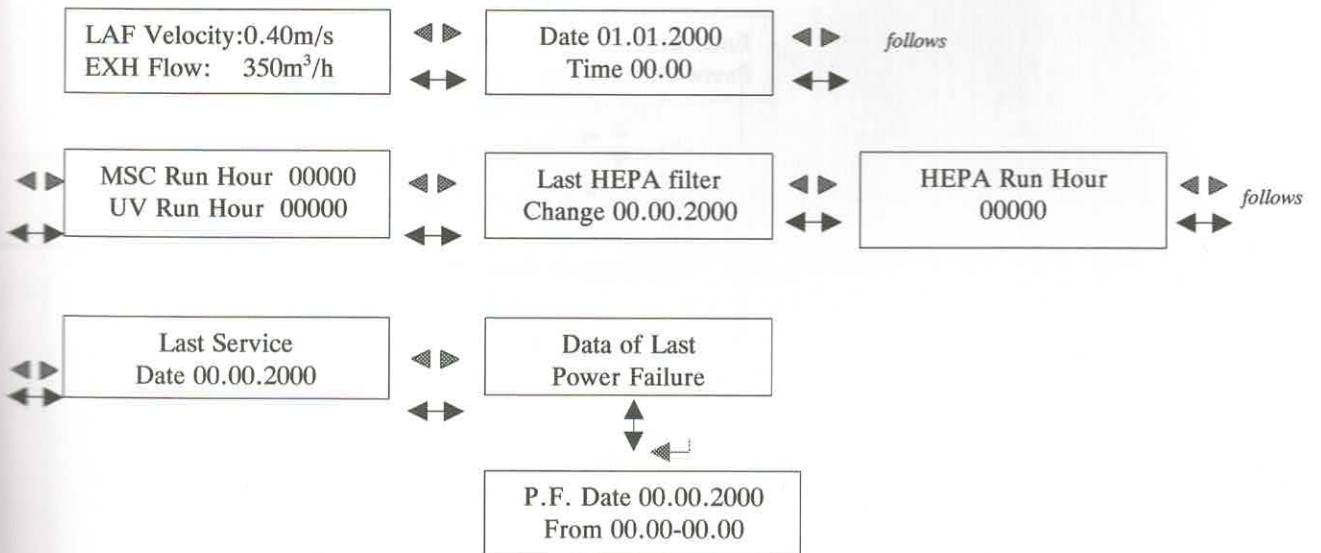

5.3.2 Mode II User

Password: 0 ↓

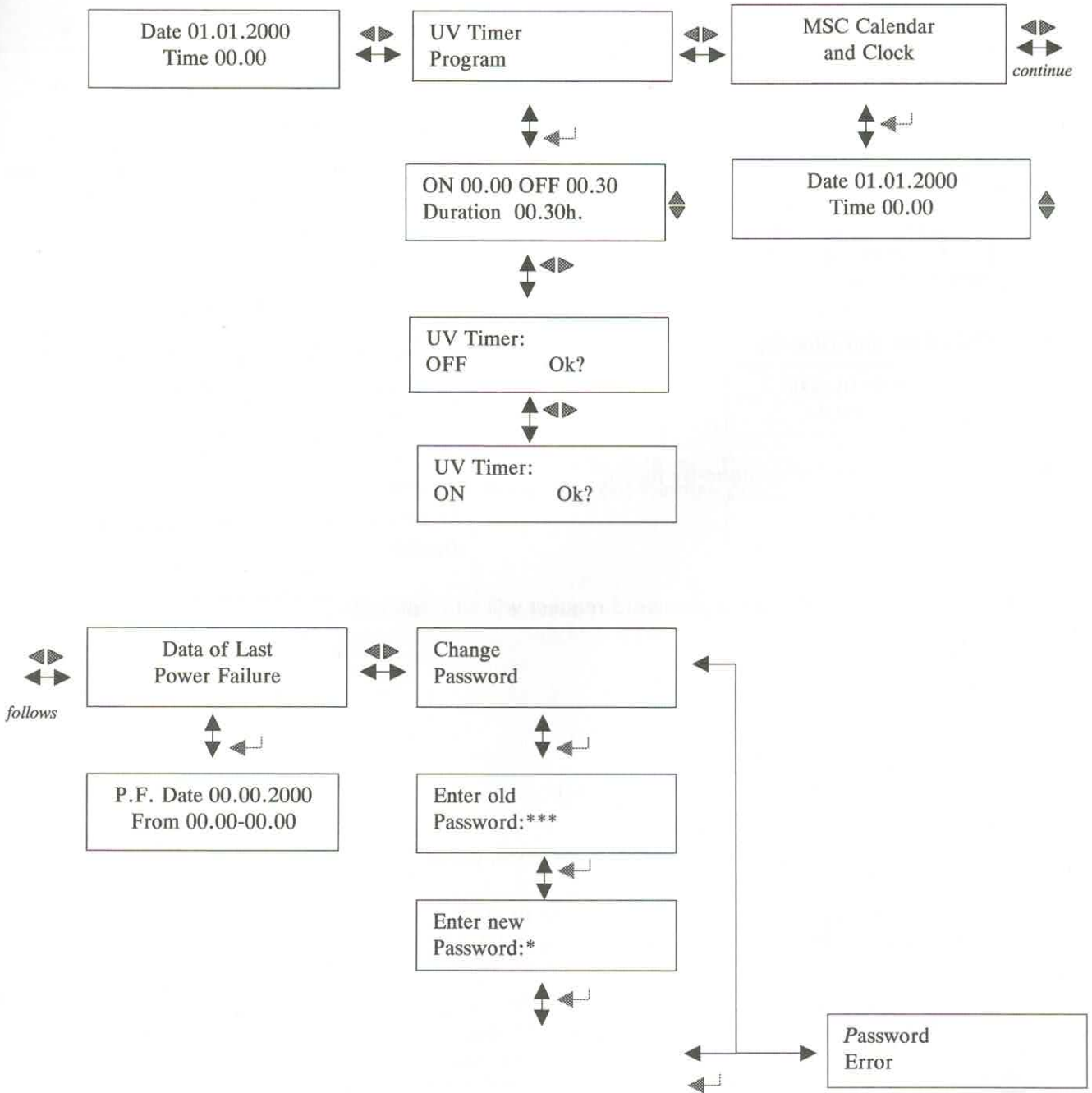

5.3.3 Client Service Mode

Password: 1967 ↓ (permanent)

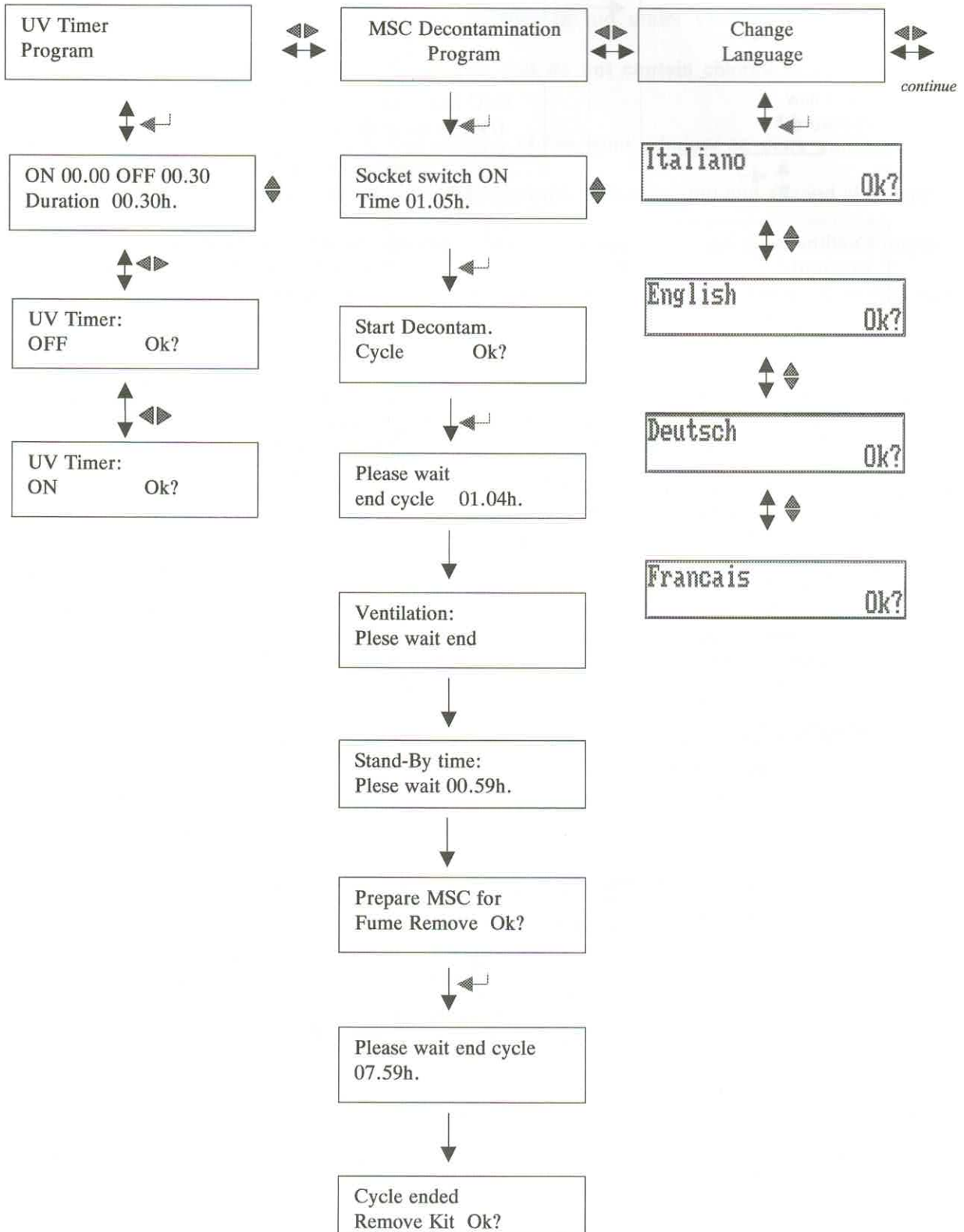



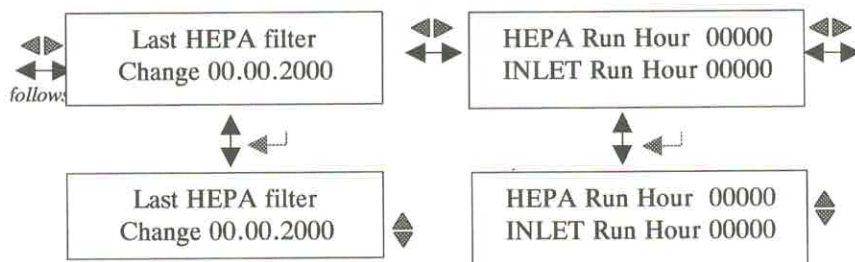
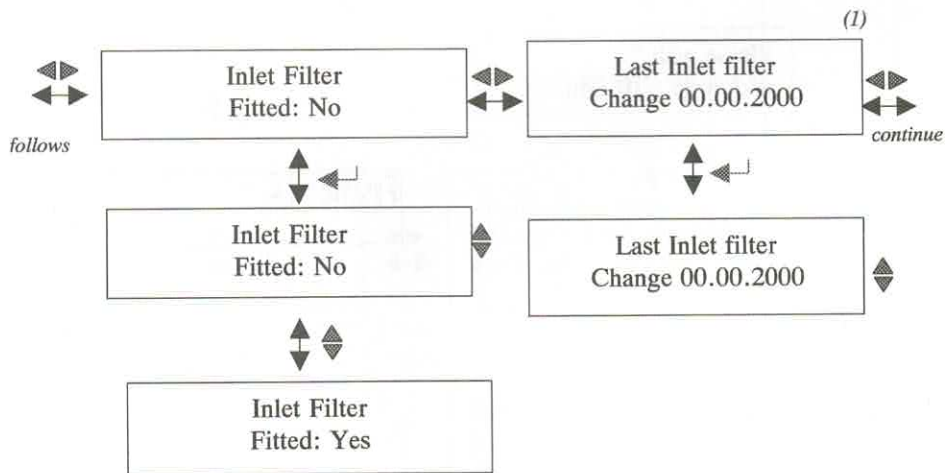
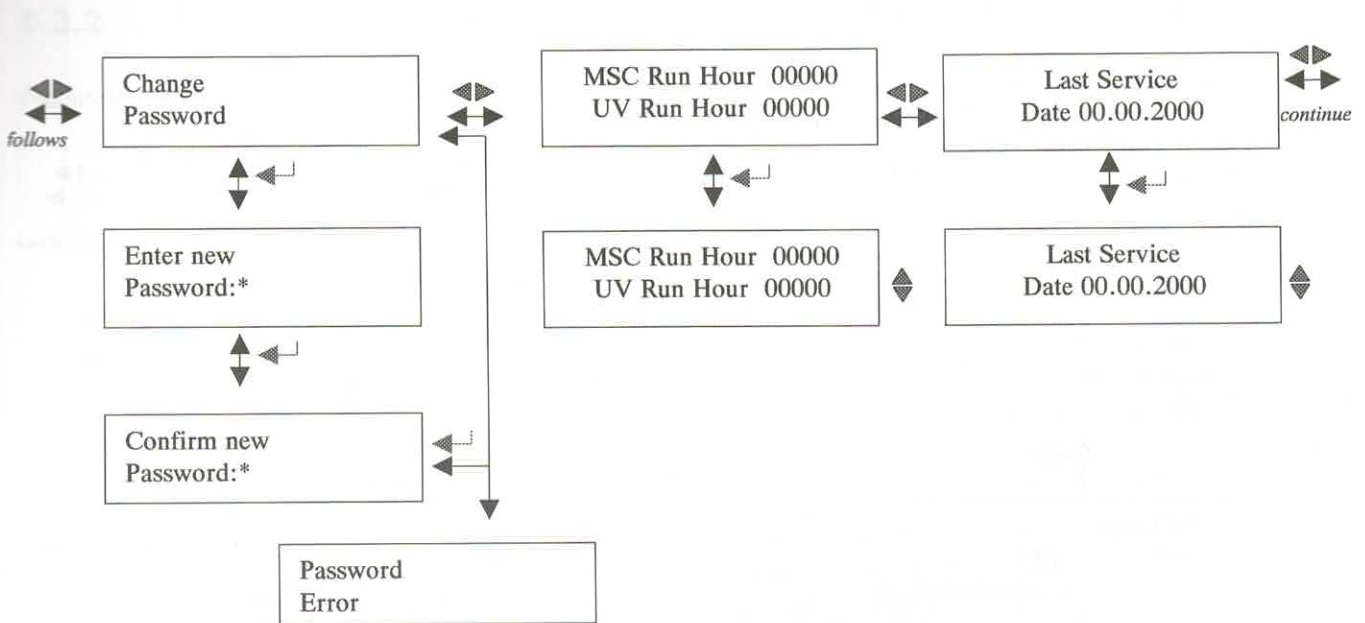

**5.3.4 ALARMS:**

LAF ALARM  
 LAF Velocity: 0.31m/s

EXH ALARM  
 EXH Flow: 320m<sup>3</sup>/h

SCREEN POSITION  
 ALARM

## 5.4 PRECAUTIONS DURING OPERATION

### **BEFORE STARTING TO WORK:**

After the alarms have turned off, leave the cabinet to run under ventilation range for 15 minutes.

The work space must be clean, use disinfectants **that do not contain chlorine (e.g. ethanol at 70%)**.

Introduce all the materials that require the opening of the front window as more cumbersome than the front opening in operative position.

Be careful with the HEPA filter even though it has it's own protection grid and second aluminium diffuser grid.

Work should be programmed the best possible, where continuous passages between the internal and the external work space are avoided.

Should the above mentioned situation occur, movements must be controlled to minimise the air turbulence that occurs inevitably.



### **BEWARE:**

Do not overload the work surface, keep it the clearest possible avoiding to obstruct the perforations and the air regain grid.

Do not cover them with paper, gauze, cloths or other items.

### **DURING OPERATION :**

The operator must follow the general safety specifications prescribed for laboratory biosafety.



### **BEWARE:**

Operations should possibly be carried out in the central part of the work surface and in any case, never close to the front air regain grid.

The minimum safety limit is 105 mm from the front window.

Only qualified personnel should be allowed to operate and must at least be trained on the following subjects:

- ☞ Classification of cabinets.
- ☞ Correct and incorrect use of a cabinet.
- ☞ Operations and warning functions of the cabinet.
- ☞ Function limits.
- ☞ How to operate safely within the work space of a cabinet.
- ☞ How to decontaminate a cabinet after it's use.
- ☞ Main aeraulic features of the cabinet and relative tests on the operator's protection.

### **AFTER WORK :**

Place the contaminated material into containers; all containers must be sealed tight, leave the cabinet to run under ventilation range for 15 minutes.

Clean the work area, use disinfectants **that do not contain chlorine (e.g. ethanol at 70%)**.

Clean the drain tray, that is situated under the work surface, by removing the section provided with a hand-knob, and then proceed in removing all the other sections. Replace the sections by going through the inverse operation.

Close the cabinet by means of the closing front panel (for version with hinged window) or by letting the front screen slide down (for version "E", with front sliding window). In this case place the UV Kit into position (see dedicated paragraph).

**BEWARE:**

Do not leave paper and or cloths and or gauze or anything similar as it could be regained by the cabinet;  
Problems arising from such an inconvenience can only be solved by the intervention of technical assistance.

## 5.5 ALARMS

The alarms (acoustic and visual) sound when the exhaust flow rate and/or the laminar airflow overtake the established threshold (see the attached test sheet of the cabinet) or when the front screen is not in the correct operating position. The display shows the masks here after reported.

|                                    |                                             |                          |
|------------------------------------|---------------------------------------------|--------------------------|
| LAF ALARM<br>LAF Velocity: 0.31m/s | EXH ALARM<br>EXH Flow: 320m <sup>3</sup> /h | SCREEN POSITION<br>ALARM |
|------------------------------------|---------------------------------------------|--------------------------|

A luminous indicator is on the soft touch panel, above the "O" button, to indicate any alarm condition.

### Front window position alarm

Acoustic and visual alarm caused by an incorrect working position of the screen. It only turns on when the key switch is in position 1. As a consequence, all operations (e.g. cleaning of the work zone, introduction of cumbersome materials), that require, for version with hinged window, the opening of the front window or, for version "E" with sliding front window, the maximum opening of the window or all operations (e.g. decontamination, work protection) that require total closure of the window, must be carried out when the cabinet is in Mode II.

### Ventilator/s cut-off

As a rule, the ventilators are cut-off by a thermal protection device that intervenes when the motor overheats. The protection device restores ventilation as soon as the temperature of the motor returns to normal.

If the ventilation cut-off repeats itself request immediate technical assistance.

**BEWARE:**

IN CASE THE ALARM TURNS ON FOLLOW THE STEPS LISTED IN PARAGRAPH 1. *GENERAL SAFETY GUIDELINES*.

BIOLOGIC SAFETY CONDITIONS MIGHT NOT BE GUARANTEED FOR ACCIDENTAL REASONS (for example structural cabinet damages or HEPA filter damages).

THE ABOVE MENTIONED CONDITIONS ARE NOT MONITORED BY THE ALARM SYSTEM.



## 6. AVAILABLE UTILITIES

All utilities that function by means of electric power feeding are to be activated through the control panel.

### 6.2 TRANSPARENT FRONT SCREEN

#### **Version with hinged window**

The cabinet is supplied with a transparent front screen, with counterbalanced opening by means of pre-compressed gas loaded piston situated outside the work zone. Lift and close the screen gently with great care.

When the screen is raised open the pre-compressed gas pistons maintain said position. Pay attention to the edged corners of the screen that remain at the same level of the operator's head.

If the cabinet is in Mode I and the screen is not in the correct working position the visual and acoustic alarm is immediately turned on.

#### **Version "E" with sliding front window**

The transparent front screen operates electrically by pressing the keys marked with a triangle. The vertex of the triangles indicate the direction of movement and they are activated only when the key switch is in position 1 or 2.

During descend and ascend of the screen, it will automatically stop at the correct height that guarantees total operation safety. If descend or ascend is to be continued, it will be necessary to repress the corresponding key.

If the Cabinet is in mode 1 and the screen is not in the correct operating position, the visual and acoustic alarm will be activated (see dedicated paragraph 5.3).

When the screen is completely shut down, ventilation is automatically excluded.

### 6.2 ILLUMINATION

The fluorescent lamp can be switched ON and OFF by means of the appropriate key placed in a specific section of the control panel when the cabinet is in Mode I or II.

In Mode II however, the fluorescent lamp is interlocked by the functioning of the UV lamp to prevent illumination in contemporary with ultraviolet radiation.

### 6.3 UV GERMICIDAL LAMP

The unit is provided with a dedicated power socket, placed on the right side of the front panel, to connect the UV germicidal lamp.

The power socket is a standard feature of the cabinet.

The UV germicidal lamp can be switched ON and OFF manually by means of the dedicated keys situated on control panel, when the cabinet is in Mode II.  
 It is not possible to switch the fluorescent and the UV lamps on at the same time as the activation of both circuits is electronically inter-locked.  
 The UV lamp can also be switched OFF by turning OFF the cabinet (Mode O).

### Version with hinged window

The germicidal UV lamp is installed on the removable closing front panel and provided with cable and plug to be connected to the dedicated socket placed on the right side of the front panel.

The germicidal UV lamp is designed to function only when the front panel is in the correct operating position, in the front part of the cabinet where the micro-contact installed on the panel itself is closed.

**NOTE:** BEFORE CONNECTING AND SWITCHING THE UV GERMICIDAL LAMP ON, THE FRONT CLOSING PANEL MUST BE PLACED IN THE CORRECT OPERATING POSITION.  
 BEFORE REMOVING THE FRONT CLOSING PANEL, SWITCH OFF THE UV LAMP BY PRESSING THE DEDICATED KEY ON THE CONTROL PANEL AND DISCONNECTING THE PLUG FROM THE POWER SOCKET.

### Version "E" with sliding front window (if supplied as optional)

The UV germicidal lamp, in the form of a kit, is supplied as optional, provided with a cord and plug to be connected to the dedicated power socket situated on the right side of the front panel.

The UV germicidal lamp is designed to function only when the kit is placed in the correct position in the front area of the cabinet so that the front screen, totally lowered, closes the micro-contact installed on the kit itself.

## 6.3.1 UV timer

A UV timer is also available in the electronic control system of the cabinet in Mode II.

As shown in the beside flow diagram, it is possible to set start time and duration of the UV treatment. By setting the UV timer in condition "ON" the procedure is activated. A flashing led indicates that a UV program has been set. Now place the UV lamp and connect it to the dedicated power socket. At the selected time UV will start automatically. Anyway it is possible to stop UV manually by pressing the relative Key on the electronic board.



**BEWARE:**

**UV RAYS ARE HARMFUL TO THE EYES AND SKIN.**  
**THEREFORE DIRECT EXPOSURE MUST BE AVOIDED.**

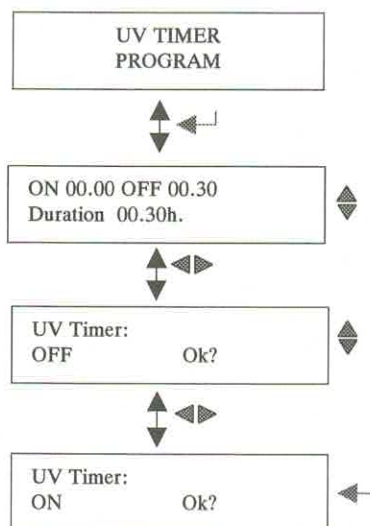

## Drawing 7.1.1 - Equipment dimensions -version "E" with sliding window-, standard packing (dimensions expressed in mm.)

MZ890 DSN

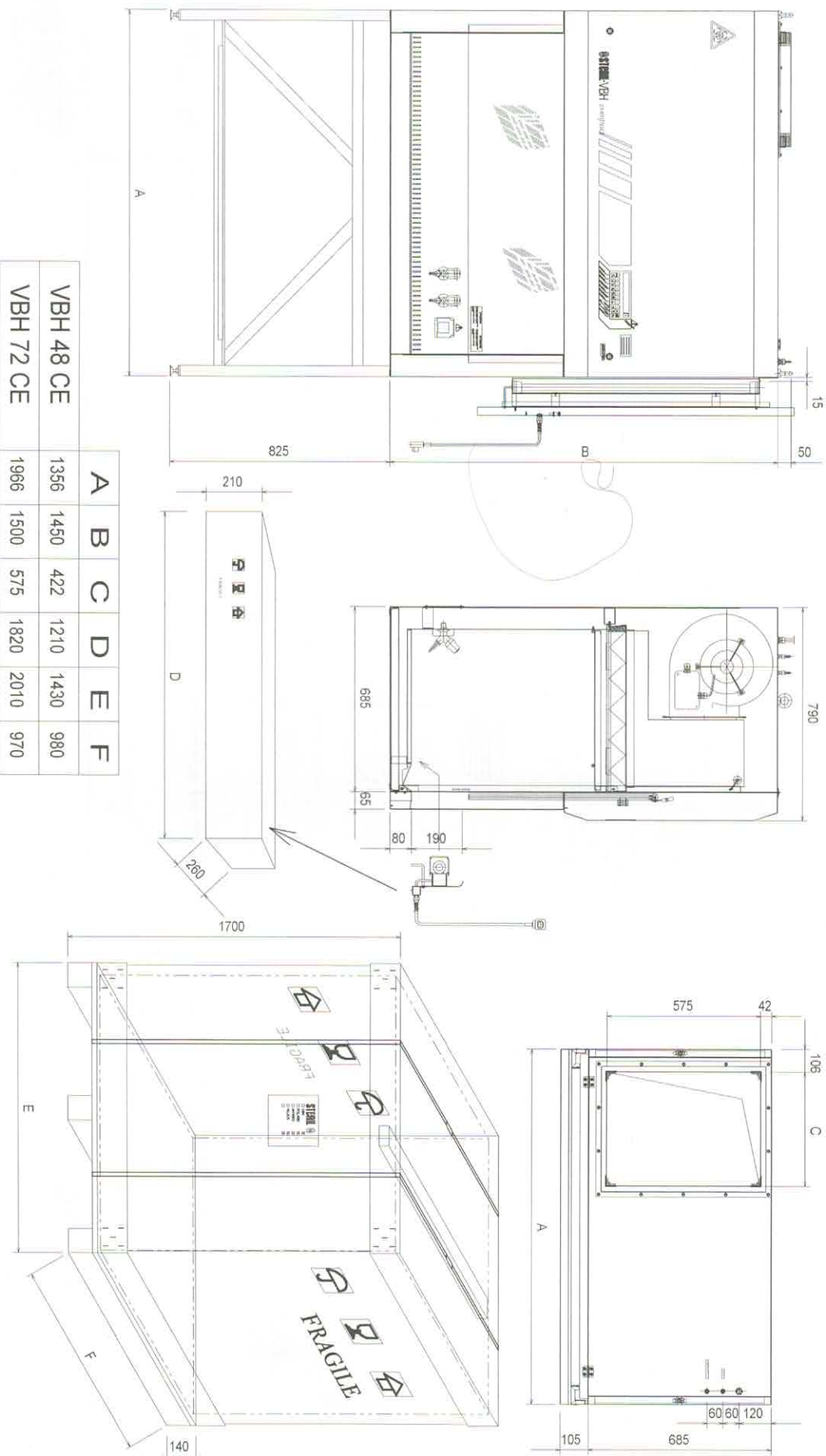



**Drawing 7.1.1.2 - Equipment dimensions -version with hinged window-, standard packing (dimensions expressed in mm)**

M2880-01 DGN

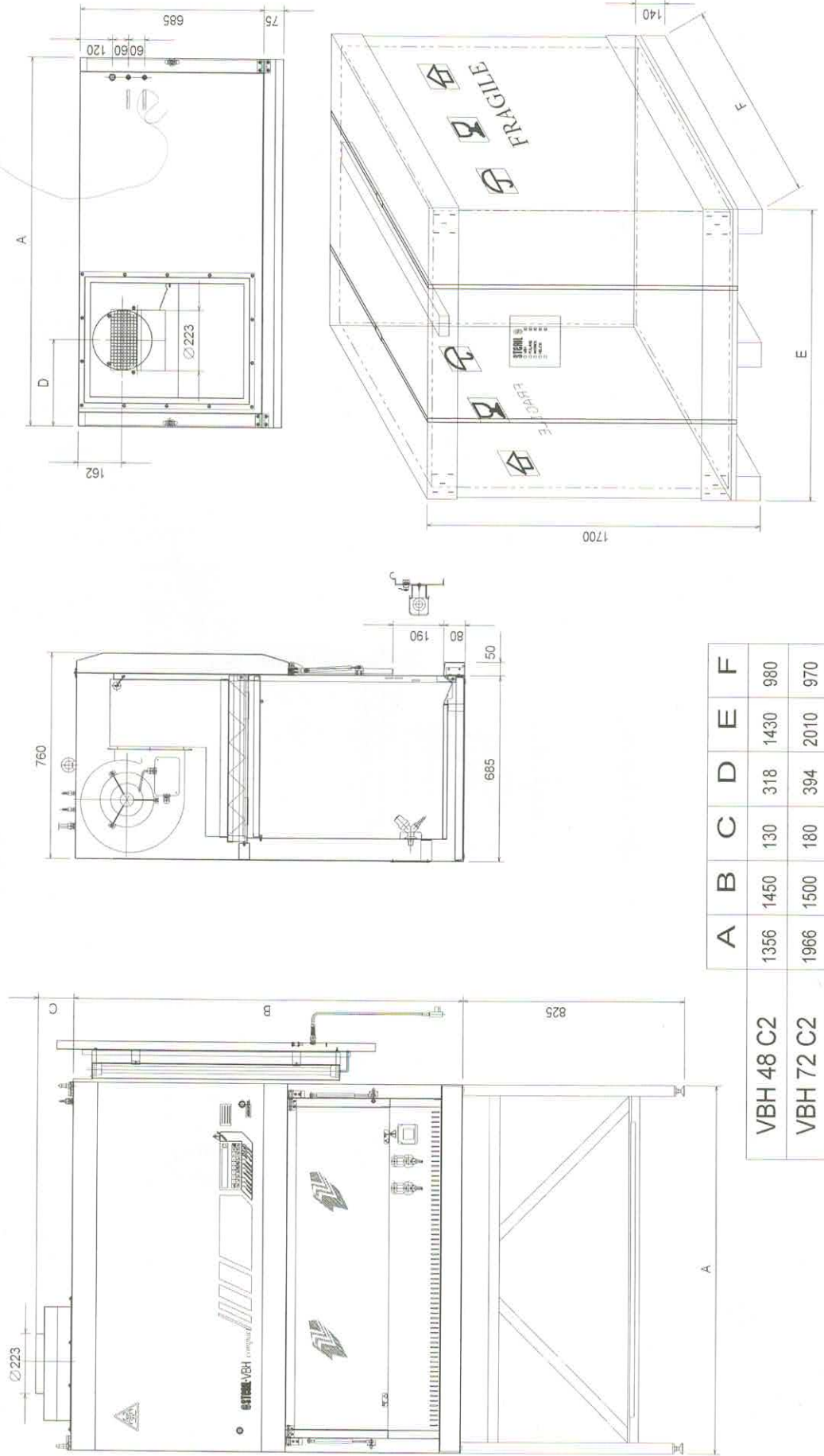

**Drawing 7.2.2 - Cabinet description -version with hinged window-**

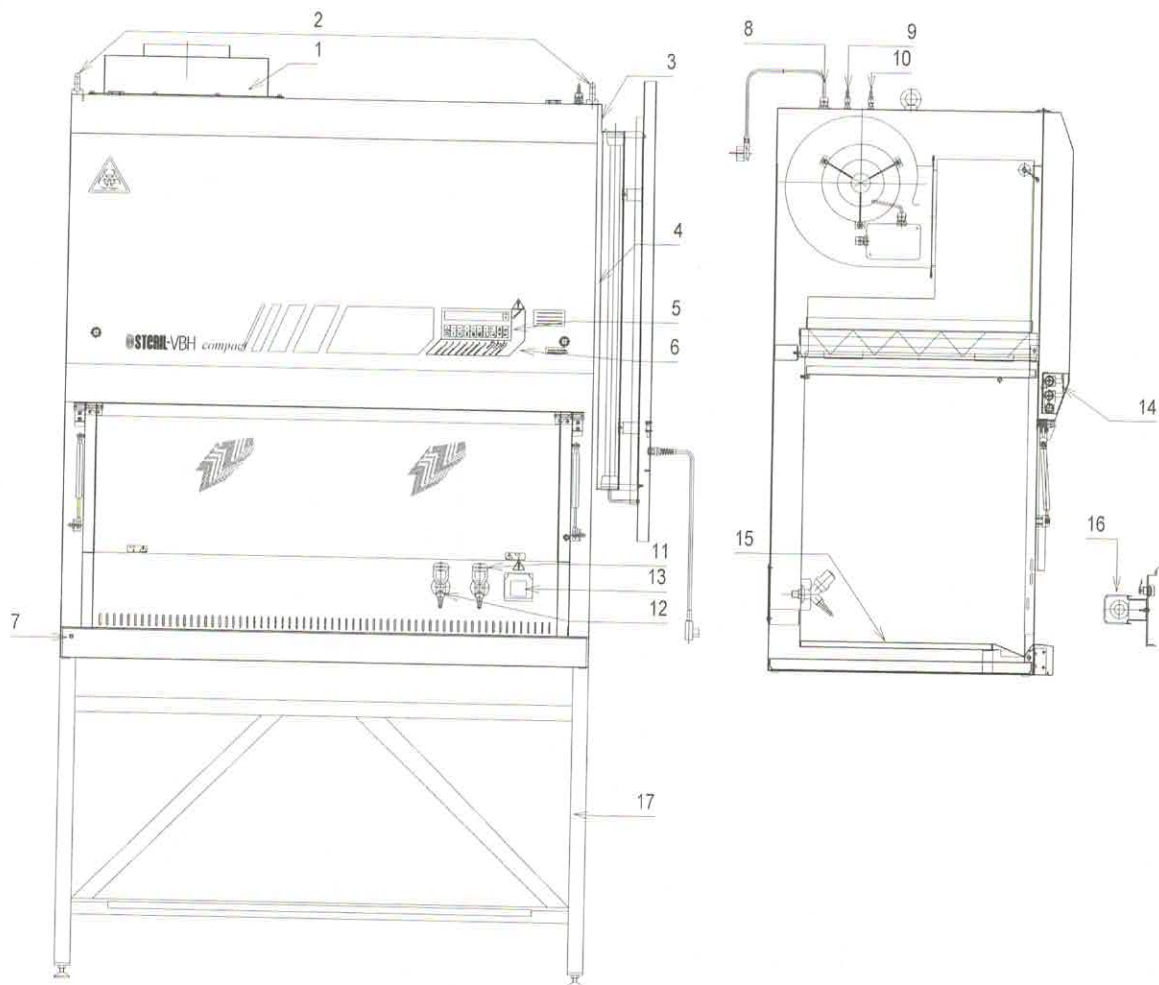

- 1 Exhaust air fitting
- 2 Eyebolts
- 3 Identification tag with technical details and S.N.
- 4 Panel power socket for UV. germicidal lamp kit
- 5 Control panel
- 6 Ideogram legend
- 7 DOP-DOS test port
- 8 Electric power feeding (cord + plug)

- 9 Vacuum hose-barb
- 10 Gas inlet hose-barb
- 11 Gas tap
- 12 Vacuum tap
- 13 Power socket
- 14 Lamp holder
- 15 Work surface
- 16 UV germicidal lamp kit
- 17 Supporting stand

**PART TWO**



## 9. GENERAL FEATURES

**BEWARE**  **BEWARE**

After having treasured the information contained in "PART ONE", the correct functioning of the equipment and operational safety are guaranteed by **STERIL S.p.A.** under the condition that all maintenance operations are carried out by authorised and trained personnel.

Access to the electric parts is only allowed to qualified personnel, trained to open the command panel and to programme the microprocessor logic.

Decontamination is compulsory, prior to all technical operations to be carried out within cabinet's interiors (at the client's care).

Prior decontamination must formally be certified in writing and signed by the purchaser of said service, using the relevant module that will be handed in before every technical operation.

The above mentioned operation is necessary to enable cabinet maintenance to be carried out in utmost safety, in complete accordance with Italian law D.Lgs. 626/94 in compliance with European Directive EEC 89/391 (modified by D.Lgs. 242/96), with particular reference to title VIII and/or safety of personnel/workers on work place laws of the country where the cabinet is to be installed.

In addition the purchaser will have to formally inform **STERIL S.p.A.** staff or **STERIL S.p.A.** Distributor, in writing with the same module, on the risks and on the prevention and protection measures to be adopted.

**STERIL S.p.A.** staff/Distributor will also have to be informed about the emergency procedures made available by the purchaser, in oral or written form.

All maintenance operations (both periodic, ordinary or extraordinary) must be carried under power safety conditions, by isolating the equipment from the main power source.

**The MODE O cannot be considered as total power cut-off. Total power cut-off means unplugging the equipment from the main power socket (see INSTALLATION paragraph).**

Ordinary maintenance consists essentially in the replacement of the following components.

- ⇒ Fluorescent lamp.
- ⇒ UV lamp (if present)
- ⇒ HEPA filters.

## 10. SPARE PART REQUESTS

It is possible to request any spare part by forwarding a written request that specifies:

- **EQUIPMENT TYPE**
- **SERIAL NUMBER**
- **DESCRIPTION OF THE SPARE PART WITH EVENTUAL ARTICLE CODE**

In this way it is easier and quicker to identify the exact model and price of the requested spare part.

Consult the paragraph entitled spare parts list.



**ATTENTION:** The spare parts to be used must have the same technical characteristics of the parts to be replaced.

The use of spare parts supplied by **STERIL S.p.A.** is recommended.

## 11. ORDINARY AND PREVENTIVE MAINTENANCE

An adequate maintenance is an important factor as it determines a major duration of the equipment's condition and guarantees safety, under a functional point of view, throughout time.

It is imperative that only authorised personnel carry out maintenance operations.

Staff must be provided with individual protection gear, normally used for such operations, and must follow the prescribed safety procedures described in the following chapter.

Also see the table of periodic maintenance.

## 12. SAFETY SPECIFICATIONS DURING MAINTENANCE



**BEWARE:** The operator in charge of ordinary cleaning **MUST** wear the required protection gear (gloves, mask, overall, eye protection, etc.).

The main precautions to adopt during maintenance are:

- ⇒ Only involve qualified and authorised personnel for complex operations.
- ⇒ Decontaminate/Sterilize the equipment before removing any panel or other part of the equipment.
- ⇒ Always disconnect the plug from the main power socket before opening the front panel or before removing any protection panel or before replacing any electrical component.
- ⇒ Never touch uncovered connections or components without having disconnected the main power (unplug the cabinet from the main power socket).
- ⇒ Do not wear rings, watches, chains, bracelets, etc. during maintenance.
- ⇒ If possible, stand on an isolating rubber mat during maintenance; avoid operating on wet floors or very humid environments.
- ⇒ Do not use flames or pins during cleaning.
- ⇒ Do not smoke.

### 13. PERIODICAL CLEANING

The equipment must be cleaned at the beginning and at the end of every work day. This enables the equipment to maintain good conditions.

The scheme below lists all the parts that have to be cleaned:

- ⇒ Work space
- ⇒ Liquid drain basin
- ⇒ Front window
- ⇒ Command panel
- ⇒ External surfaces

**Use the appropriate products for cleaning**



**BEWARE:**

**DO NOT CLEAN THE STAINLESS STEEL SURFACES WITH PRODUCTS CONTAINING CHLORINE.**

**Specific products may be used to clean specific parts of the cabinet.  
Always refer to the technical card and the instructions that accompany the cleaning product.  
Use the appropriate products for cleaning. Consult also the STERIL S.p.A. technical service**

The work surface is divided into sections to enable it's sterilisation by means of an autoclave.

To remove the work surface start by the first section on the left that is provided with a handle, then proceed in removing all the other sections.

Any liquids accidentally spilled are collected into the drain basin that is situated under the work surface.

The drain basin can be accessed by removing the work surface.



**14. TABLE OF ORDINARY PERIODIC MAINTENANCE**

| <i>N°</i> | <i>OPERATION</i> | <i>PART OF UNIT</i>             | <i>advised PRODUCT</i>                                           | <i>PERIOD</i> |
|-----------|------------------|---------------------------------|------------------------------------------------------------------|---------------|
| 1         | Cleaning *       | Command panel                   | Cloth + Distilled water + liquid soap                            | Daily         |
| 2         | Cleaning *       | Work space                      | Disinfectant containing quaternary ammonium salts or ethanol 70° | Daily         |
| 3         | Cleaning *       | Front screen                    | Disinfectant containing quaternary ammonium salts or ethanol 70° | Daily         |
| 4         | Cleaning *       | External parts of the equipment | Cloth + Distilled water + liquid soap                            | Weekly        |

\* **DO NOT CLEAN THE WORK SPACE AND ALL OTHER STAINLESS STEEL SURFACES WITH PRODUCTS CONTAINING CHLORINE.**

All other surface may be cleaned with specific products for that area, refer to the technical card and instructions attached to the product.  
 Consult the **STERIL S.p.A.** technical service.

**BEWARE:**

The operator in charge of ordinary cleaning **MUST** be provided with individual protection gear and devices.

## 15. TABLE OF PERIODIC CONTROLS

| N° | OPERATION                   | PART OF EQUIPMENT                                             | METHOD                                                                                                                                                                                                                           | PERIOD                                                                           |
|----|-----------------------------|---------------------------------------------------------------|----------------------------------------------------------------------------------------------------------------------------------------------------------------------------------------------------------------------------------|----------------------------------------------------------------------------------|
| 1  | Functional control          | Signals of the control panel                                  | Visual: check that all the luminous leds flash for an instant after ignition (check-panel function)                                                                                                                              | upon ignition                                                                    |
| 2  | Functional control          | Buttons on the control panel                                  | Manual                                                                                                                                                                                                                           | Upon their use or monthly                                                        |
| 3  | Functional control          | Alarms                                                        | Visual / Acoustic<br>Note : The aeraulic alarms always turn on upon ignition until the safety conditions are reached<br>The wrong screen position alarms turns on when the front window is not in the correct operating position | Upon ignition                                                                    |
| 4  | Screw clamping              | End-run - position of the front window.<br>Front panel hinge. | Visual / Manual                                                                                                                                                                                                                  | Every 6 months *                                                                 |
| 5  | Screw clamping              | electronic terminal board                                     | Visual / Manual                                                                                                                                                                                                                  | Every 6 months *                                                                 |
| 6  | Verification of integrity   | internal and external surfaces                                | Visual                                                                                                                                                                                                                           | Upon ignition *                                                                  |
| 7  | Installation testing        |                                                               | See dedicated paragraph                                                                                                                                                                                                          | After installation *                                                             |
| 8  | Routine maintenance testing |                                                               | See dedicated paragraph                                                                                                                                                                                                          | Advised every 6 months or after technical assistance.<br>Compulsory every year * |
| 9  | Wear verification           | Electric cables, feeding cord                                 | Visual                                                                                                                                                                                                                           | Every 6 months *                                                                 |
| 10 | Wear verification           | Lifting belts of the transparent front screen                 | Visual                                                                                                                                                                                                                           | Every 6 months *                                                                 |

- and every time the cabinet is moved or, in any case, whenever reasons arise for it to be moved (e.g. after having executed work close to the cabinet)



**16. PROBLEM SOLVING TABLE (DEFECTS RESEARCH)**

IN ANY CASES OF ALARM THE BIOLOGICAL SAFETY CONDITIONS ARE **NO LONGER GUARANTEED**, THE OPERATIONS IN COURSE MUST BE INTERRUPTED IMMEDIATELY, STORE ALL DANGEROUS MATERIALS INTO BIOHAZARD TIGHTLY SEALED CONTAINERS AND PLACE WITHIN THE CABINET, LOCK THE FRONT OPENING ACCESS OF THE CABINET, SHUT DOWN THE UNIT AND REQUEST IMMEDIATE TECHNICAL ASSISTANCE.

DO NOT USE THE CABINET UNTIL AUTHORISED TECHNICAL ASSISTANCE HAS OPERATED .

| ANOMALY                                                                                               | COUNTER MEASURE / VERIFICATION                                                                                                                                                                                                                       | NOTES                                                                                                  |
|-------------------------------------------------------------------------------------------------------|------------------------------------------------------------------------------------------------------------------------------------------------------------------------------------------------------------------------------------------------------|--------------------------------------------------------------------------------------------------------|
| The unit does not work and all leds are switched off                                                  | Check the voltage of the power plug.<br>Check the various fuses (see electrical diagram)                                                                                                                                                             | It could be caused by incorrect electrical connections, irregular power voltage, burnt out fuses, etc. |
| The lamps do not function even though the power is turned on                                          | Check the various fuses (see electrical diagram).<br>Check the efficiency of the fluorescent tubes.                                                                                                                                                  |                                                                                                        |
| Ventilation does not turn on                                                                          | Check the voltage<br>Check that the cabinet is on MODE I<br>Check that the front screen is in the correct operating position.<br>Check the functions of the actuator group & micro-release into position<br>Check the thermal protection of the fan. |                                                                                                        |
| Ventilation turns on (the dedicated led flash), but the ventilator does not work                      | Check the relevant fuses (see electrical diagram).                                                                                                                                                                                                   | It can be caused by the thermal protection of the motor that blocks the ventilator                     |
| The front window does not automatically stop in the correct operating position (sliding version only) | Check the functions of the actuator group & micro-release into position                                                                                                                                                                              |                                                                                                        |
| Wrong front screen position alarm                                                                     | Place the screen in the correct work position.<br>If the alarm continues, switch the unit off and then re-activate.<br>If the alarm persists after first re-activation, contact the STERIL S.p.A. technical assistance.                              |                                                                                                        |

**NOTE:** As already mentioned in the alarm dedicated paragraph, the aeraulic alarms of the VENTILATOR BLOCK can be caused by the intervention of the thermal protection that prevents the overheating of the motors.

The protection device restores the motor's functions once the causes of overheating have been eliminated and ventilator returns to the normal functional temperatures allowed.

If the thermal protection turns once more, the defect might be of electrical or mechanical nature.

Request immediate STERIL S.p.A. technical assistance that will substitute the ventilator if necessary.