

QuantStudio™ 1 Real-Time PCR System

INSTALLATION, USE, AND MAINTENANCE

Firmware v1.1

Publication Number MAN0017853

Revision C



For Research Use Only. Not for use in diagnostic procedures.



Revision history: MAN0017853 C (English)

Revision	Date	Description
C	8 August 2024	<ul style="list-style-type: none">Information about using tubes/tube strips was added (“Options for loading MicroAmp™ consumables with the QuantStudio™ 1 Real-Time PCR System” on page 23 and “Prepare samples using MicroAmp™ tubes/ tube strips with separate cap strips” on page 24).Caution information about flat caps for tubes was moved to “Prepare samples using MicroAmp™ tubes/tube strips with separate cap strips” on page 24.Information about instrument power issues during runs was added (“View run history and delete or transfer files from the instrument” on page 25).Minor verbiage was updated.
B.0	22 July 2021	<ul style="list-style-type: none">Updated the name of the cloud-based platform to Thermo Fisher™ Connect.Added instructions for connecting to the Thermo Fisher™ Connect cloud-based platform.Updated the firewall instrument-to-computer port number.Added Network and password security requirements sectionAdded Perform internal validations before software upgrades sectionUpdates Environmental design table in the Appendix E, SafetyChanged all references to Bleach, 10% solution to Na-hypochlorite (0.1% v/v) solution
A.0	10 October 2018	New document.

The information in this guide is subject to change without notice.

DISCLAIMER: TO THE EXTENT ALLOWED BY LAW, THERMO FISHER SCIENTIFIC INC. AND/OR ITS AFFILIATE(S) WILL NOT BE LIABLE FOR SPECIAL, INCIDENTAL, INDIRECT, PUNITIVE, MULTIPLE, OR CONSEQUENTIAL DAMAGES IN CONNECTION WITH OR ARISING FROM THIS DOCUMENT, INCLUDING YOUR USE OF IT.

Important Licensing Information: These products may be covered by one or more Limited Use Label Licenses. By use of these products, you accept the terms and conditions of all applicable Limited Use Label Licenses.

Trademarks: All trademarks are the property of Thermo Fisher Scientific and its subsidiaries unless otherwise specified. TaqMan is a registered trademark of Roche Molecular Systems, Inc., used under permission and license. Cy is a registered trademark of GLOBAL LIFE SCIENCES SOLUTIONS GERMANY GMBH. Microsoft and Windows are trademarks of Microsoft Corporation. Pentium is a trademark of Intel Corporation. Google and Chrome are trademarks of Google, Inc.

©2018-2024 Thermo Fisher Scientific Inc. All rights reserved.

Contents

About this guide	8
■ CHAPTER 1 Product information	9
Network and password security requirements	9
Network configuration and security	9
Password security	9
Perform internal validations before software upgrades	9
Instrument hardware description	10
Instrument overview	10
Parts of the instrument	11
Parts of the home screen	12
Software description	14
Features of the instrument, desktop, and Thermo Fisher™ Connect software	14
Folders, templates, experiments, and projects	15
Third-party software	17
Supported options for instrument and computer connections	17
Experiment types	19
■ CHAPTER 2 General procedures to operate the instrument	21
Precautions for use	21
Power on the instrument	22
Power off the instrument	22
Sign in	22
Sign out	23
Options for loading MicroAmp™ consumables with the QuantStudio™ 1 Real-Time PCR System	23
Load and unload a plate in the instrument	23
Prepare samples using MicroAmp™ tubes/tube strips with separate cap strips	24
Transfer, view, or manage files and results	25
Transfer EDS files from the instrument home screen	25
View run history and delete or transfer files from the instrument	25
Manage templates (EDT files)	26

- **CHAPTER 3** Configure the instrument and manage instrument profiles 27
 - Initial start-up 27
 - Installation and instrument verification 28
 - Use the instrument without signing in 28
 - Create an administrator instrument profile during initial start-up 28
 - Create a new instrument profile 29
 - Overview of **Settings** 30
 - Manage instrument settings 32
 - Manage the instrument name (Administrator only) 33
 - Enable **Sleep Mode** 33
 - Set the idling temperature for the heated cover 33
 - Configure the network drive 33
 - OEM connection only (Administrator only) 34
 - Select a region for Thermo Fisher™ Connect (Administrator only) 34
 - Set the date and time (Administrator only) 34
 - Configure the network 34
 - Restore factory defaults 36
 - Select a language 36
 - Learn about the instrument 36
 - View instrument specifications 36
 - View and export the License Agreement 37
 - Manage home screen notifications 37
 - Manage maintenance, service, and calibrations 37
 - Update instrument software (Administrator only) 37
 - Enable remote instrument monitoring (Administrator only) 38
 - View instrument statistics 38
 - View instrument logs 38
 - Manage Users 39
 - Require instrument profile sign-in (Administrator only) 39
 - Manage the **Sign Out Timer** (Administrator only) 39
 - Manage instrument profiles 39
 - Link an instrument profile to Thermo Fisher™ Connect 40
 - Recommended order to set up profiles 41
 - Overview of local instrument profiles and Thermo Fisher™ Connect profiles 41
 - Thermo Fisher™ Connect instrument profile roles and functions 42
 - Test the connection to the Thermo Fisher™ Connect platform 42
 - Link the instrument to your Thermo Fisher™ Connect account 42
 - Link a local profile to a Thermo Fisher™ Connect profile 43
 - Unlink a Thermo Fisher™ Connect account 45
 - If you link when you *are* signed in to the instrument 45
 - Change the PIN for a Thermo Fisher™ Connect profile 46

■	CHAPTER 4	Create and run experiments on the instrument	47
	Workflow		47
	Run an experiment		48
	Create and run an experiment from a template		48
	Run an experiment from a saved file		48
	Repeat the last instrument run		49
	Edit an experiment before starting a run		50
	Enter or edit template properties		50
	Edit the run method		51
	Define, assign, and view well details		54
	View, pause, or stop a run		55
	View real-time data and plots on the instrument touchscreen		55
	Adjust the display of real-time plots on the instrument touchscreen		55
	Pause or stop an instrument run		55
	Lock the touchscreen during a run		56
	Transfer EDS files from the instrument home screen		56
■	CHAPTER 5	Calibrate and verify instrument performance	57
	Calibration and verification schedule		57
	Calibration descriptions		58
	View the calibration status and set reminders		59
	View calibration status and set reminders in the instrument		59
	View calibration status and set reminders in Thermo Fisher™ Connect		59
	Perform ROI/uniformity, background, and dye calibrations		60
	Workflow: Calibration		60
	Prepare a calibration plate		61
	Perform calibrations		62
	View calibration images and transfer results to USB		63
	Troubleshoot calibration failure		64
	Identify contamination		64
	Create a background plate (<i>optional</i>)		65
	Perform instrument verification using RNase P plates		65
	Instrument verification description		66
	RNase P instrument verification plate		66
	Performance specifications pass criteria		67
	Prepare an RNase P plate		67
	Perform RNase P verification		68
	Troubleshoot verification failure		69
	Calibrate custom dyes		70
	Custom dyes overview		70
	Use a dilution series to determine an optimal custom dye concentration		70
	Calibrate the custom dye		72
	Calibrate for a custom melt curve experiment		75

- **CHAPTER 6 Maintain the instrument** 77
 - Backup or restore the instrument 77
 - Decontaminate the sample block 78
 - Materials required 78
 - Clean the sample block 78
 - Detailed procedures for cleaning the sample block 80
 - Replace the instrument fuses 81
 - Materials required 81
 - Replace the fuses 81
 - Prepare the instrument to store, move, or ship 82
 - Move the instrument 82
 - Return the instrument for service 83

- **APPENDIX A Install and connect the instrument to a network** 84
 - Workflow: Install and connect to a network 84
 - Before you begin 85
 - Instrument and computer connections 85
 - Unpack and install the instrument 86
 - Power on and follow the startup wizard 87
 - Connect the computer to the instrument directly or to a LAN 87
 - Networking 88
 - Supported options for instrument and computer connections 88
 - Control and monitor networked instruments 90
 - Ethernet port overview 90
 - Firewall ports that must be open 90
 - Networking guidelines and best practices 91

- **APPENDIX B Troubleshooting** 92

- **APPENDIX C Instrument specification and layout** 94
 - Configured system dimensions 95
 - Instrument clearances 96
 - Electrical requirements 96
 - Environmental requirements 97
 - Network requirements 97

■	APPENDIX D	Parts and materials	99
		Kits, consumables, accessories, and reagents	99
		Consumables (96-well, 0.2-mL format)	99
		Accessories	100
		General-use materials and consumables	100
■	APPENDIX E	Safety	102
		Symbols on this instrument	102
		Conformity symbols	103
		Safety alerts on this instrument	104
		Location of safety labels on the instrument	105
		Safety information for instruments not manufactured by Thermo Fisher Scientific	106
		Instrument safety	106
		General	106
		Physical injury	106
		Electrical safety	106
		Cleaning and decontamination	107
		Safety and electromagnetic compatibility (EMC) standards	107
		Safety compliance	107
		EMC	108
		Environmental design	108
		Chemical safety	110
		Biological hazard safety	111
		Documentation and support	112
		Related documentation	112
		Obtain information from the Help system	112
		Customer and technical support	112
		Limited product warranty	113
		Index	114

About this guide

This guide provides information about installing, using, and maintaining the QuantStudio™ 1 Real-Time PCR System. For information and instructions on performing experiments on this system, refer to *QuantStudio™ Design and Analysis Desktop Software User Guide* (Pub. No. MAN0010408).



Product information

- Network and password security requirements 9
- Perform internal validations before software upgrades 9
- Instrument hardware description 10
- Software description 14
- Supported options for instrument and computer connections 17
- Experiment types 19

Network and password security requirements

Network configuration and security

The network configuration and security settings of your laboratory or facility (such as firewalls, anti-virus software, network passwords) are the sole responsibility of your facility administrator, IT, and security personnel. This product does not provide any network or security configuration files, utilities, or instructions.

If external or network drives are connected to the software, it is the responsibility of your IT personnel to ensure that such drives are configured and secured correctly to prevent data corruption or loss. It is the responsibility of your facility administrator, IT, and security personnel to prevent the use of any unsecured ports (such as USB, Ethernet) and ensure that the system security is maintained.

Password security

Thermo Fisher Scientific strongly recommends that you maintain unique passwords for all accounts in use on this product. All passwords should be reset upon first sign in to the product. Change passwords according to your organization's password policy.

It is the sole responsibility of your IT personnel to develop and enforce secure use of passwords.

Perform internal validations before software upgrades

IMPORTANT! If you have a validated workflow, you must perform all internal validations as required by your organization's standard operating procedures before performing a software upgrade.

Instrument hardware description

Instrument overview

The QuantStudio™ 1 Real-Time PCR System uses fluorescence-based polymerase chain reaction (PCR) reagents to perform the following types of experiments.

- Quantitative detection of target nucleic acid sequences (targets).
- Qualitative detection of targets.
- Qualitative analysis of the PCR product.

For more information, see “Experiment types” on page 19.



The instrument is configured with a 96-well 0.2-mL fixed block and a 3-color coupled filter set.

The instrument can be run directly from the touchscreen to create and start experiments. To design experiments or to analyze data, the instrument can be integrated with the QuantStudio™ Design and Analysis Desktop Software.

An optional barcode scanner and optional wireless adapter can be ordered separately.

Instrument filters and supported dyes

System dyes

The instrument use a coupled three-color filter set that supports the dyes shown in the following table and figure. For more information about available spectral dye calibration kits, contact Support.

Peak filter	Color	Filter wavelength (nm) ^[1]		Factory-calibrated dyes	Example custom dyes
		Excitation	Emission		
x1-m1	Blue	470 ± 15	520 ± 15	FAM™, SYBR™ Green	SYT09
x2-m2	Green	520 ± 10	558 ± 12	VIC™	JOE™, HEX™, TET™ ^[2]
x4-m4	Orange	580 ± 10	623 ± 14	ROX™, JUN™	Texas Red™

^[1] The central wavelengths are the optimized wavelengths.

^[2] The HEX™ and TET™ dyes from Thermo Fisher Scientific fall within the emission wavelength range of the system, therefore they can be added and adapted for use on the instrument.

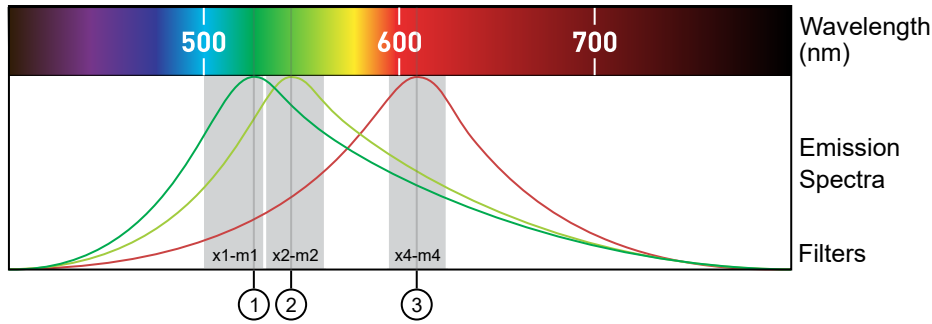

① x1-m1 — FAM™, SYBR™ Green

② x2-m2 — VIC™

③ x4-m4 — JUN™, ROX™, Texas Red™

Custom dyes

The instrument can run assays that are designed with custom dyes. Custom dyes include the following dyes:

- Dyes that are not supplied by Thermo Fisher Scientific.
- Dyes or formulations of dyes that are not system dyes for the instrument.

To use a custom dye on the instrument, review the following requirements:

- Calibrate the instrument for the custom dye (see “Calibrate custom dyes” on page 70).
- Ensure that the custom dye excites and emits within the wavelength range of the filters (see “System dyes” on page 10).
- Select a custom dye that does not overlap with other dyes that are used in the run (see “System dyes” on page 10).

Parts of the instrument

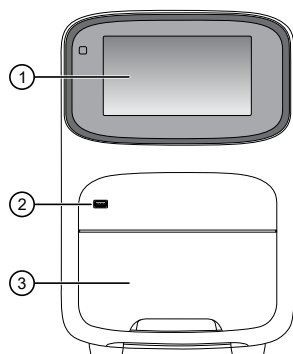

① **Touchscreen**—Controls the instrument.

② **USB port**—For connection to an external network drive or external data storage device.

③ **Instrument drawer**—Holds the sample plate.

The instrument includes three additional USB ports on the back of the instrument.

Note: The instrument recognizes only one external storage device at a time for data transfer.

Parts of the home screen



- ① Avatar and Instrument name
- ② Help icon
- ③ Drawer status
- ④ Status dial
- ⑤ Current user name; instrument block type
- ⑥ **Settings** button
- ⑦ Buttons for accessing Experiment Template files (EDT)
- ⑧ Connectivity icons
- ⑨ **Sign In** (or **My Profile**) button

Table 1 Parts of the home screen

Element of the home screen	Function	For more information, see...
Avatar and Instrument name	Set by the administrator to uniquely identify instrument.	"Manage the instrument name (Administrator only)" on page 33
Help icon	Touch to launch the touchscreen Help system to access step-by-step instructions.	—

Table 1 Parts of the home screen (continued)











Element of the home screen	Function	For more information, see...
Drawer status	<ul style="list-style-type: none"> •  — The drawer is locked. The drawer locks during experiment runs, calibration runs, and self verification test runs. The drawer automatically unlocks when a run is complete. •  — The drawer is unlocked. • Drawer is open — The drawer is open. No message displays when the drawer is closed. 	—
Status dial	<ul style="list-style-type: none"> • When the instrument is in use — Displays the sample block temperature, the elapsed run time, and the run status. You can swipe the dial to the left or touch  to access real-time views of the run. • When the instrument is not in use — Displays Set up run. You can start a run by touching the status dial. 	—
Current user name and block type	<p>Displays the user name of the current signed-in user and the instrument block type.</p> <p>Note: If no user is signed-in, the instrument defaults to the Guest profile.</p>	—
Settings button	Touch  Settings to configure, calibrate, or learn about the instrument.	Chapter 3, “Configure the instrument and manage instrument profiles”
Buttons for accessing experiment and template files	Load Experiment — Touch to open a user-created EDT file from a Thermo Fisher™ Connect account, USB, instrument folder, or network drive.	“Run an experiment from a saved file” on page 48 .
	Open Template — Touch to open a system EDT template file.	“Create and run an experiment from a template” on page 48 “Run an experiment from a saved file” on page 48
	Run Last — Touch to open the last EDT file run on the instrument. <ul style="list-style-type: none"> • If you are signed-in, the file opened will be the last file you ran when signed-in. • If you are not signed-in, the file opened will be the last file the guest profile ran. 	“Repeat the last instrument run” on page 49

Table 1 Parts of the home screen (continued)

Element of the home screen	Function	For more information, see...
Connectivity icons	<ul style="list-style-type: none"> •  — The instrument is connected to a wired network. •  — The instrument is wirelessly connected. •  — A USB drive is plugged into the instrument. •  — The instrument is linked to a Thermo Fisher™ Connect account. 	—
Sign In button (My Profile button when a user is signed in)	<ul style="list-style-type: none"> • Touch  Sign In to sign into an instrument profile and link to a Thermo Fisher™ Connect account. • Touch  My Profile to change instrument profile settings, link to a Thermo Fisher™ Connect account, or lock the instrument during a run. 	“Sign in” on page 22

Software description

Features of the instrument, desktop, and Thermo Fisher™ Connect software

The instrument and the software (desktop and Thermo Fisher™ Connect) include the features described in the following table.

Software feature	Instrument	Desktop	Thermo Fisher™ Connect
Use as guest (no sign in)	✓	✓	—
Create templates (unlocked or locked)	—	✓	✓
Edit unlocked templates	✓	✓	✓
Edit locked templates (password assigned by template creator required)	—	✓	✓
Load system or user-created templates (EDT file) to instrument	✓	✓	—



(continued)

Software feature	Instrument	Desktop	Thermo Fisher™ Connect
Change experiment settings in template (EDT file) loaded on the instrument Settings that can be changed in a locked template (no password required): <ul style="list-style-type: none"> • Properties: All settings • Method: No changes allowed • Plate: Sample names Settings that can be changed in an unlocked template: <ul style="list-style-type: none"> • Properties: All settings • Method: All settings • Plate: Sample names 	✓	—	—
Load plate in instrument	✓	—	—
Start run	✓	✓	—
View real-time data during a run	✓	✓	✓
View instrument status (running, calibration needed, and so on)	✓	—	✓
Analyze results	—	✓	✓
Set calibration reminders	✓	—	✓
Review exported calibration or RNase P verification results	—	✓	✓ <i>(only RNase P)</i>

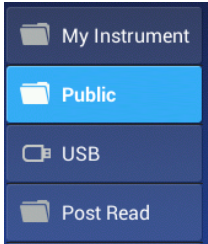
Folders, templates, experiments, and projects

Term	Definition	Supported in
Folders in Load Experiment 	Location in which you can store templates (EDT files) on the instrument: <ul style="list-style-type: none"> • My Instrument – Displayed if you are signed in • Public – Location in which all experiments run by guest users are stored • USB – USB for manual transfer to and from a computer • Post Read – If you run an endpoint experiment, the pre-read experiment is automatically saved in this folder for post-read analysis 	Instrument

(continued)

Term	Definition	Supported in
Experiment Template File (EDT)  	Default settings for an instrument run, can be modified before instrument run. Two types: <ul style="list-style-type: none"> • Factory-provided, accessed from Open Template (instrument) or Create Experiment (desktop or Thermo Fisher™ Connect) • User-created, accessed from Load Experiment 	Instrument Desktop Thermo Fisher™ Connect
Experiment Run File (EDS)	Settings and data for a completed instrument run.	Instrument Desktop Thermo Fisher™ Connect
Project 	Function in the Cloud Data Manager that is used for secondary analysis applications. Does not apply to Thermo Fisher™ Connect software, which is a primary analysis application.	Thermo Fisher™ Connect

Template and experiment components	Instrument	Desktop	Thermo Fisher™ Connect
Properties	<ul style="list-style-type: none"> • Experiment file name • Reagent information (Reagent barcode, Lot#) • Plate barcode • Data destination (location for auto-transfer of data) • Comments (Tags are not used at this time) 	<ul style="list-style-type: none"> • Experiment file name • Plate barcode • User name • Instrument type • Block type • Experiment type • Chemistry (reagent information) • Run mode • Comments • (Thermo Fisher™ Connect only) Notifications 	
Method	Thermal cycling conditions	Thermal cycling conditions	
Plate	Sample names You cannot edit targets/SNP assays or tasks on the instrument.	Define and assign samples, targets or SNP assays, and tasks in the Quick Setup and Advanced Setup panes of the Plate tab.	

(continued)

Template and experiment components	Instrument	Desktop	Thermo Fisher™ Connect
Run	Start and monitor a run in progress View: time remaining and temperature, method, plots Pause, resume, stop a run	Start and monitor a run in progress View: time remaining and temperature, method, plots	Monitor a run in progress (link to Thermo Fisher™ Connect Instrument Details) View: time remaining and temperature, method, plots
Results	Not applicable	Review plots	
Export	Not applicable	Export results	

Third-party software

Before installing third-party software on the computer running QuantStudio™ Design and Analysis Desktop Software, confirm that the third-party software will not do the following:

- Restrict Ethernet communication.
- Interfere with instrument or computer operation.

Supported options for instrument and computer connections

We support the following direct, networked (LAN–local area network), or Thermo Fisher™ Connect configurations. Configurations other than those listed are not recommended. Select a configuration that meets the needs of your laboratory's instrument, software, and workflow requirements.

IMPORTANT! Do *not* connect *both* an Ethernet cable and the Wi-Fi module (Cat. No. A26774) to the instrument. Configuring the instrument for both wired and wireless connection can interfere with instrument operation.

Note: For detailed information about networking your instrument, see the *QuantStudio™ 1 Real-Time PCR System IT Checklist* (Pub. No. MAN0018164).

Direct configuration option

- A computer provided by Thermo Fisher Scientific with the QuantStudio™ Design and Analysis Desktop Software

- Computer-to-instrument connection:
 - Direct, wired connection between the computer and the instrument using an Ethernet cable



IMPORTANT! A direct instrument-to-computer connection *cannot* be combined with the LAN or the Thermo Fisher™ Connect configurations.

Networked configuration option

- A computer provided by Thermo Fisher Scientific with the QuantStudio™ Design and Analysis Desktop Software
- The computer and instrument must have the same subnet mask within the same network.

- Computer-to-LAN connection (*select an option*):
 - Wired connection to the network using an Ethernet cable –or–
 - Wireless connection to the network

- Instrument-to-LAN connection (*select an option*):
 - Wired connection to the network using an Ethernet cable –or–
 - Wireless connection to the network using the instrument Wi-Fi module

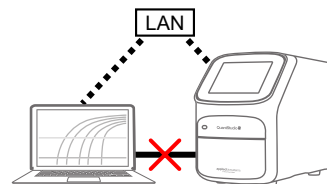

Thermo Fisher™ Connect configuration option

- Internet access and a computer with the Chrome™ web browser to access Thermo Fisher™ Connect

- Computer-to-Thermo Fisher™ Connect connection (*select an option*):
 - Wired connection to the internet using an Ethernet cable –or–
 - Wireless connection to the internet

- Instrument-to-Thermo Fisher™ Connect connection (*select an option*):
 - Wired connection to the network using an Ethernet cable –or–
 - Wireless connection to the network using the instrument Wi-Fi module

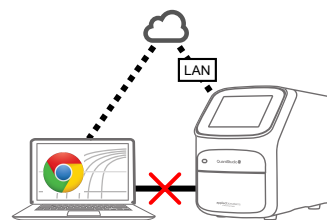

Experiment types

Purpose	Description
Standard curve experiment	
Determines absolute target quantity in samples.	<ol style="list-style-type: none"> 1. The software measures amplification of the target in a standard dilution series and in test samples. 2. The software generates a standard curve using data from the standard dilution series. 3. Using the standard curve, the software interpolates the absolute quantity of target in the test samples.
Relative standard curve experiment	
Determines relative target quantity in samples.	<ol style="list-style-type: none"> 1. The software measures amplification of the target of interest and of an endogenous control target in a standard dilution series, in a reference (calibrator) sample, and in test samples. The endogenous control is a target that is expressed equally in all samples; examples of endogenous controls are β-actin, GAPDH, and 18S ribosomal RNA. The software can algorithmically incorporate multiple endogenous control targets in relative quantification calculations. The reference sample is used as the basis for relative quantification results (or 1\times sample). For example, in a study of drug effects on gene expression, an untreated control is an appropriate reference sample. 2. The software generates standard curves for the target of interest and the endogenous control using data from the corresponding standard dilution series. 3. Using the standard curves, the software interpolates the quantities of the target of interest and the endogenous control in each sample. The target quantity in each sample is then normalized to the sample's endogenous control quantity. 4. To determine the relative quantity of the target in test samples, the software divides the normalized target quantity in the sample by the normalized target quantity in the reference sample.

Purpose	Description
Comparative C_t ($\Delta\Delta C_t$) experiment	
Determines relative target quantity in samples.	<ol style="list-style-type: none"> The software measures amplification of the target of interest and of an endogenous control target in a reference (calibrator) sample and in test samples. The endogenous control is a target that is expressed equally in all samples; examples of endogenous controls are β-actin, GAPDH, and 18S ribosomal RNA. The software can algorithmically incorporate multiple endogenous control targets in relative quantification calculations. The reference sample is used as the basis for relative quantification results (or 1\times sample). For example, in a study of drug effects on gene expression, an untreated control is an appropriate reference sample. The measurements for the target of interest are normalized to the endogenous control. To determine the relative quantity of the target in test samples, the software compares the normalized ΔC_q (ΔC_t or ΔC_{rt}) for the sample to the normalized ΔC_q (ΔC_t or ΔC_{rt}) for the reference sample.
Genotyping experiment	
Detects single nucleotide polymorphism (SNP) variants of a target nucleic acid sequence.	<p>Genotyping experiments use preformulated TaqMan™ SNP Genotyping Assays that include:</p> <ul style="list-style-type: none"> Two sequence-specific primers for amplification of sequences containing the SNP of interest Two allele-specific TaqMan™ probes for Allele 1 and Allele 2 <ol style="list-style-type: none"> The software normalizes the fluorescence of the reporter dyes to the fluorescence of the passive reference dye in each well. The software plots the normalized reporter dye signal of each sample well on an Allelic Discrimination Plot, which contrasts the reporter dye intensities of the allele-specific probes. The software algorithmically clusters the sample data, and assigns a genotype call to the samples of each cluster according to its position on the plot.
Presence/absence experiment	
Determines the presence or absence of a target nucleic acid sequence in a sample.	The software calls the target present or absent based on an algorithmically determined call threshold. (The call threshold is different from the C_t threshold; the C_t threshold is not used to make calls.)
Melt curve experiment	
Determines the melting temperature (T_m) of the amplification products of a PCR that used intercalating dyes.	<p>In the software, melt curve analysis is included in the default run method for any experiment type that uses intercalating dyes.</p> <ol style="list-style-type: none"> The software plots a melt curve based on the fluorescence of the dye with respect to change in temperature. Using the melt curve, the software calculates the melting temperature (T_m).

2

General procedures to operate the instrument

- Precautions for use 21
- Power on the instrument 22
- Power off the instrument 22
- Sign in 22
- Sign out 23
- Options for loading MicroAmp™ consumables with the QuantStudio™ 1 Real-Time PCR System 23
- Load and unload a plate in the instrument 23
- Prepare samples using MicroAmp™ tubes/tube strips with separate cap strips 24
- Transfer, view, or manage files and results 25

Precautions for use



CAUTION! PHYSICAL INJURY HAZARD. Do not remove the instrument cover. There are no components inside the instrument that you can safely service yourself. If you suspect a problem, contact technical support.



CAUTION! FIRE HAZARD. For continued protection against the risk of fire, replace fuses only with listed and certified fuses of the same type and rating as those currently in the instrument.



CAUTION! PHYSICAL INJURY HAZARD. During instrument operation, the sample block temperature can reach 100°C. Allow it to cool to room temperature before handling.



CAUTION! Before using a cleaning or decontamination method other than those recommended by Thermo Fisher Scientific, confirm with Thermo Fisher Scientific that the proposed method will not damage the instrument.



CAUTION! Use flat caps for tubes. Rounded caps can damage the heated cover.

Power on the instrument

1. Touch anywhere on the touchscreen to determine if the instrument is in sleep mode. If the home screen is displayed, the instrument is already powered on.
2. If the home screen does not display, power on the instrument by pressing the switch on the rear panel.

If left unattended, the instrument automatically enters sleep mode (enabled by default) to conserve power.

Note: To customize the sleep mode setting, touch  **Settings** ▶ **Instrument Settings** ▶ **Sleep Mode**.

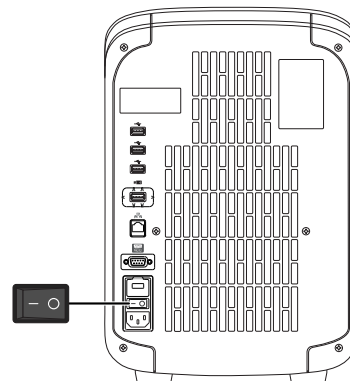

Power off the instrument

The instrument operates in low-power mode when not in use. However, the instrument can be powered off completely so that the components use no power.

Note: To power off the instrument for >1 week, see “Prepare the instrument to store, move, or ship” on page 82.

1. Power off the instrument using the power switch on the back of the instrument.
2. Power off the computer.

Sign in

Create an instrument profile before signing into the instrument. See “Create a new instrument profile” on page 29.

Note: An instrument profile is a user account specifically for the instrument. It is not related to any other user account for the system or software.

1. In the home screen, touch  **Sign In**.
2. Touch **Sign In**, then select your username.
3. Enter your PIN, then touch **Enter**.

Sign out

1. In the home screen, touch  **My Profile**.
2. Touch **Sign Out**.

Options for loading MicroAmp™ consumables with the QuantStudio™ 1 Real-Time PCR System

(Recommended) If using MicroAmp™ reaction plates, proceed to “Load and unload a plate in the instrument” on page 23.

If using MicroAmp™ tubes/tube strips, proceed to “Prepare samples using MicroAmp™ tubes/tube strips with separate cap strips” on page 24.

Load and unload a plate in the instrument

1. Load the plate.
 - a. Open the instrument drawer.
 - b. Load the plate onto the plate adapter so that the following criteria are met.
 - Well A1 of the plate is in the top-left corner of the plate adapter.
 - The barcode faces the front of the instrument.

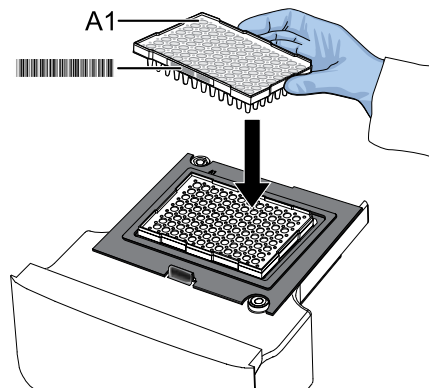

Note: Do not remove the black plate adapter before loading a plate or tube strips. If used, tube strips can fit loosely in the adapter, but the heated cover will apply the appropriate pressure to seat the tube strips securely in the adapter.

- c. Close the instrument drawer.
2. When the run ends, unload the plate.
 - a. Open the instrument drawer.

- b. Remove the plate.
- c. Close the instrument drawer.



CAUTION! PHYSICAL INJURY HAZARD. During instrument operation, the plate temperature can reach 100°C. Allow it to cool to room temperature before handling.

Prepare samples using MicroAmp™ tubes/tube strips with separate cap strips



CAUTION! Use flat caps for 0.2-mL tubes. Rounded caps can damage the heated cover.

The following procedure describes how to properly load and seal MicroAmp tube strips using flat cap strips and the MicroAmp 96-well tray/retainer set. For a visual demonstration, watch the video "How to use adapter tray retainers" by visiting [PCR/qPCR Plastics and Seals Education](https://www.thermofisher.com/PCR/qPCR/Plastics-and-Seals-Education) at [thermofisher.com](https://www.thermofisher.com).

1. Separate the **blue** tray and retainer by squeezing the release catch as indicated in the graphic.

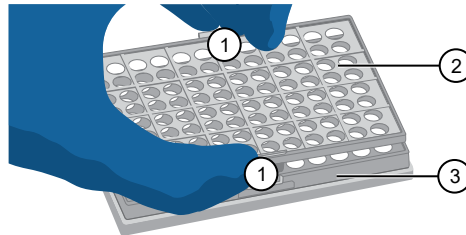

- ① Release catch
- ② MicroAmp™ 96-Well Retainer
- ③ MicroAmp™ 96-Well Tray

2. Place the **blue** tray on the 96-well base.
3. Load the tube strips on the tray.
4. Pipette the reaction mixture into the tubes.
5. Place the **blue** retainer over the tubes and snap the retainer into the tray.
6. Seal the tube strip using a MicroAmp™ cap strip.
7. Remove the **blue** tray/retainer assembly containing the sealed tube strips from the 96-well base and place the assembly on the instrument block with the black adapter on the block.

Note: Ensure the tubes and **blue** tray and retainer fit properly into the wells on the block. The tube, tray, and retainer assembly may feel loose and demonstrate some movement within the block, which is standard. The appropriate amount of pressure will be applied when the heated cover is lowered onto it.

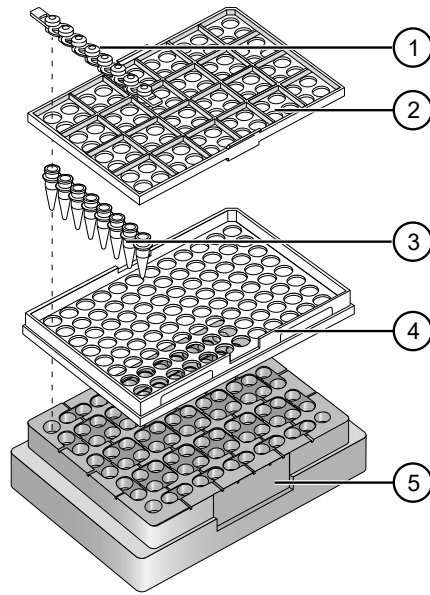

- ① MicroAmp™ 8-Cap strip
- ② MicroAmp™ 96-Well Retainer
- ③ MicroAmp™ 8-Tube Strip (0.2-mL) or MicroAmp™ Reaction Tube without Cap (0.2-mL)
- ④ MicroAmp™ 96-Well Tray
- ⑤ MicroAmp™ Splash Free 96-Well Base

Transfer, view, or manage files and results

Transfer EDS files from the instrument home screen

1. In the home screen, when a run ends, touch **Transfer File**.
2. Select the data destination for the EDS file.
3. Navigate to and select a folder.
4. Touch **OK**.
5. Touch **Transfer**.

Note: Touch ⚙ **Settings** ▶ **Run History** to transfer EDS files at any time.

View run history and delete or transfer files from the instrument

When SAE mode is enabled, only an Administrator can delete a run.

In the home screen, touch  **Settings** ▶ **Run History**.



- Touch an individual run record to view its details, then complete one of the following actions:
 - Touch **Delete** to delete the run record.
 - Touch **Transfer** to export the run data.
- Touch **Manage** to select multiple run records for simultaneous viewing, deletion, or transfer.



Note:

- Guests (users not signed-in) can only view guest run records.
- Users signed into their instrument profiles can also view their own run records.
- Administrators can view all run records.

Note: The instrument automatically resumes interrupted runs due to power outages within an hour, even without software connection. If network issues disrupt the connection during a desktop-initiated run, the run completes on the instrument with data saved in its history. For incomplete desktop-initiated runs, data must be manually transferred to a USB or network drive. Data stays in the internal memory on the instrument until manually deleted or reset.

Manage templates (EDT files)

This feature applies to templates (EDT files) on a  **USB** or in  **My Instrument**. To manage run results files (EDS files), see “Transfer EDS files from the instrument home screen” on page 25.

1. In the home screen, touch  **Load Experiment**.
2. Touch  **USB** or  **My Instrument**.
3. Touch **Manage Files**.
4. (Optional) Navigate through the **My Instrument**, **Public**, **USB**, and **Post Read** folders to access an EDT file. Folder availability depends on your sign-in status.
5. Touch one or more files to select for managing.
6. Delete or copy the files.
 - Touch **Delete Files**, then confirm deletion.
 - Touch **Copy Files**, select a file destination, then touch **Paste Files**.
7. Touch **Done**.

3

Configure the instrument and manage instrument profiles

■ Initial start-up	27
■ Installation and instrument verification	28
■ Use the instrument without signing in	28
■ Create an administrator instrument profile during initial start-up	28
■ Create a new instrument profile	29
■ Overview of Settings	30
■ Manage instrument settings	32
■ Learn about the instrument	36
■ Manage home screen notifications	37
■ Manage maintenance, service, and calibrations	37
■ Manage Users	39
■ Link an instrument profile to Thermo Fisher™ Connect	40

Initial start-up

Perform these tasks during initial instrument start-up or after you restore factory defaults (see “Restore factory defaults” on page 36).

1. (Optional) Select one of the following options.
 - Configure the instrument for either wired connection or wireless network connection (see “Configure the network” on page 34).
 - Touch **Neither/Decide Later**.
2. (Optional) Enter an instrument name (see “Manage the instrument name (Administrator only)” on page 33).
3. Set the date and time (see “Set the date and time (Administrator only)” on page 34).
4. Select one of the following options.
 - Select a region for Thermo Fisher™ Connect.
 - Touch **Next** to continue.

5. Create an administrator profile (see “Create an administrator instrument profile during initial start-up” on page 28).
6. Select one of the following options.
 - Link the instrument profile to Thermo Fisher™ Connect (see “Link an instrument profile to Thermo Fisher™ Connect” on page 40).
 - Touch **Skip**.

Installation and instrument verification

Before the first use of the instrument, complete the following tasks:

- Install the instrument (see “Unpack and install the instrument” on page 86).
- Verify instrument performance (see “Perform instrument verification using RNase P plates” on page 65).

Note:

- Instruments are factory calibrated, so no calibration is necessary at installation. However, we recommend that you verify instrument performance before using the instrument.
 - Regular calibration and verification should be performed according to the calibration and verification schedule (see “Calibration and verification schedule” on page 57).
-

Use the instrument without signing in

If the instrument is configured by an Administrator to allow guest access (⊗ **Settings** ▶ **Manage Users** ▶ **Sign In Required** set to off), you can use the instrument without signing in.

The following limits are in place if you do not sign in to the instrument:

- All actions are recorded to **Guest** user profile.
- You have access only to the **Public** folder for selecting and storing experiments.
- You cannot transfer data to Thermo Fisher™ Connect (only to USB or network drive).

Create an administrator instrument profile during initial start-up

During initial start-up, the user is automatically prompted to create an administrator instrument profile. See “Initial start-up” on page 27.

- The first instrument profile that is created during installation is given administrator privileges.
- Administrators can grant administrative privileges to other users. See “Manage all instrument profiles (Administrator only)” on page 40.

1. Touch **Name**, enter a username, then touch **Done**.
2. Touch **PIN**, enter a four-digit numerical password, then touch **Enter**.

Note: Touch the **Show PIN** checkbox to switch PIN display on or off.

3. Touch **Confirm PIN**, then repeat step 2.
4. Touch **Create profile**.

Create a new instrument profile

1. In the home screen, touch  **Sign In**, then touch **Get Started**.
2. Touch **Name**, enter a username, then touch **Done**.
3. Touch **PIN Code**, enter a four-digit numerical password, then touch **Enter**.

Note: Touch the **Show PIN** checkbox to switch PIN display on or off.

4. Touch **Confirm PIN**, then repeat step 2.
5. Touch **Create profile**.
6. Sign in to the profile you just created.
See “Sign in” on page 22.

Note: To enable access to Thermo Fisher™ Connect, see “Link an instrument profile to Thermo Fisher™ Connect” on page 40.

Overview of Settings

Touch  **Settings** in the home screen to configure settings as needed.

Access to many settings are restricted to administrator instrument profiles.

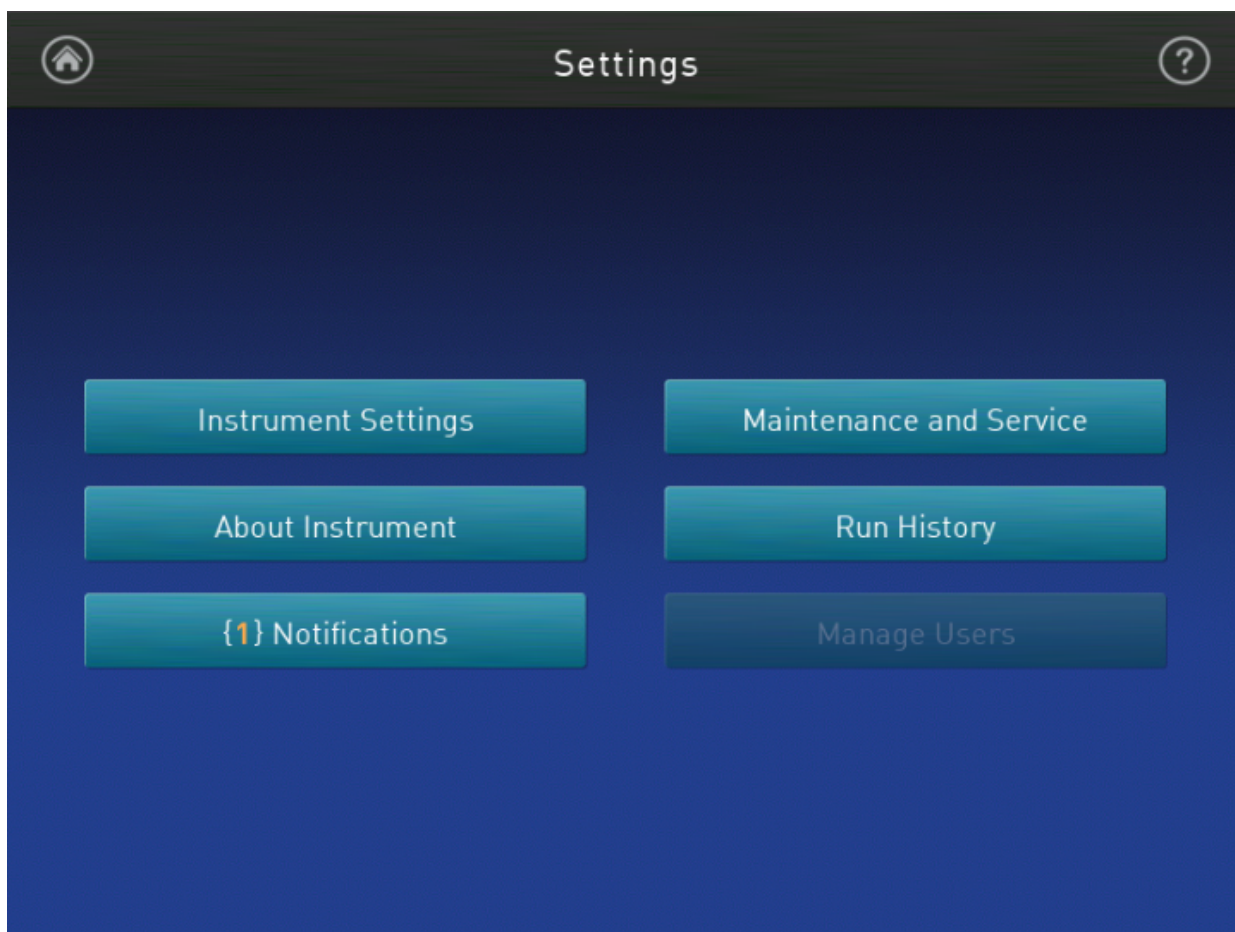

Touch  for step-by-step instructions on configuring settings.

Options	Description
Instrument Settings	
Instrument Name (Administrator only)	Enter a unique instrument name.
Sleep Mode	Enable the instrument to enter a standby mode after a set length of inactivity.
Heated Cover Temperature	Set the idling temperature for the heated cover (before it enters sleep mode).
Network Drive^[1]	Specify a default network drive for transferring files from the instrument.
Insert Plate Reminder	Enable a reminder to insert a plate before starting a run from the instrument.

Options	Description
OEM Connection Only (Administrator only)	Required for API access to the instrument. When enabled, the software (desktop and Thermo Fisher™ Connect) cannot connect to the instrument. API access to the instrument is exclusive to authorized OEM partners.
Thermo Fisher™ Connect Region (Administrator only)	Specify the regional server location to access Thermo Fisher™ Connect. Note: Once you set a region for the Thermo Fisher™ Connect Platform, restore factory defaults to change the region.
Date/Time	Set time zone and date and time formats.
Network Connection	Set wired or wireless network connection for the instrument.
Restore Factory Defaults	Restore the instrument to the factory settings. IMPORTANT! Back up the instrument before restoring factory defaults (see “Backup or restore the instrument” on page 77). Note: Restoring an instrument to the factory defaults results in the following setting changes: <ul style="list-style-type: none"> • Instrument profiles and files stored on the instrument are deleted, including all EDS files and any custom dye calibrations. • The most recent valid ROI/Uniformity, Background, and system dye calibrations are not deleted.
Language	Specify the language to display on the touchscreen.
About Instrument	
About Instrument	Displays the instrument Model Name , Block Serial Number , and Firmware Version .
License Agreement	Displays the End User Software License Agreement and the Limited Product Warranty. You can export the License Agreement to a USB drive.
Notifications	
—	Enable home screen notifications of instrument errors and software updates. This function is not related to the Notifications function in Thermo Fisher™ Connect. The number of new, unviewed notifications displays over Settings in the home screen.
Maintenance and Service	
Software Update (Administrator only)	Update the instrument software.
Monitoring (Administrator only)	Enable the Remote Monitoring Service to automatically notify Thermo Fisher Scientific support teams in real-time of potential instrument problems. The service monitors and sends general <i>instrument</i> data, but the service does not monitor or send <i>customer</i> data.
Instrument Statistics	Displays instrument usage information including Block Cycle Count and LED Life .

Options	Description
Calibrations	<ul style="list-style-type: none"> Perform calibrations <ul style="list-style-type: none"> ROI and Uniformity Dye Custom (including Background calibration) View calibration history and set calibration reminders in History and Reminders
RNase P Verification	Perform instrument performance verification using an RNase P plate.
Self Verification Test	Check the instrument hardware functions.
Log	View and export Instrument Run Log .
Backup / Restore	<ul style="list-style-type: none"> Backup the instrument^[1] Restore an instrument backup
Ship Prep Mode	Place the instrument in a safe state for moving or long term storage.
Run History	
—	Displays the instrument runs and whether the EDS file for the run was transferred. Touch a run to view the details or to transfer or delete (Administrator only) the EDS file.
Manage Users	
Sign In Required (Administrator only)	Enable only signed-in users to access the instrument for any task, including accessing Settings . Enabling this feature disables the guest profile access to the instrument. Note: Instrument runs must be started from the desktop software, and actions during an instrument run are automatically logged to the guest instrument profile (even if a user was signed into the instrument).
Sign Out Timer (Administrator only)	Set the time length of inactivity before a user is automatically signed out.
Manage Profiles (Administrator only)	Access the profile information for the instrument.

^[1] Also available to standard and guest instrument profiles.

Manage instrument settings

In the home screen, touch  **Settings** ▶ **Instrument Settings** to access the following functions.

“Manage the instrument name (Administrator only)” on page 33

“Enable Sleep Mode” on page 33

“Set the idling temperature for the heated cover” on page 33

“Configure the network drive” on page 33

“OEM connection only (Administrator only)” on page 34

“Select a region for Thermo Fisher™ Connect (Administrator only)” on page 34

“Set the date and time (Administrator only)” on page 34

“Configure the network” on page 34

“Restore factory defaults” on page 36

“Select a language” on page 36

Manage the instrument name (Administrator only)

1. In the home screen, touch  **Settings** ▶ **Instrument Settings** ▶ **Instrument Name**.
2. Touch the **Instrument Name** field, enter an instrument name, then touch **Done**.
3. Touch **OK**.

Enable Sleep Mode

1. In the home screen, touch  **Settings** ▶ **Instrument Settings** ▶ **Sleep Mode**.
2. Slide the control **On** to enable sleep mode.
3. Touch **Edit Time**, then enter the time length of inactivity before the instrument enters sleep mode.
4. Touch **Enter**, then touch **OK**.

Set the idling temperature for the heated cover

1. In the home screen, touch  **Settings** ▶ **Instrument Settings** ▶ **Heated Cover Idle Temperature**.
2. Slide the control **On** to set the idling temperature for the heated cover.
3. Touch the **Edit Temperature** field, then enter the desired idling temperature.
4. Touch **Enter**, then touch **OK**.

Configure the network drive

1. In the home screen, touch  **Settings** ▶ **Instrument Settings** ▶ **Network Drive**.

Note: Contact a representative from your information technologies department for the IP address.

2. Enter a **Drive Location**.
3. Enter a **Domain Name**, **User Name**, and **Password**, if required.
4. Touch **Connect**.

OEM connection only (Administrator only)

This setting is required for API access to the instrument. When enabled, the desktop software cannot connect to the instrument. Do not access unless instructed to do so by a service representative.

Select a region for Thermo Fisher™ Connect (Administrator only)

During the initial startup, you are prompted to select a region for Thermo Fisher™ Connect. Return to the selection through  **Settings**, if necessary.

The region is set for the instrument.

1. In the home screen, touch  **Settings** ▶ **Instrument Settings** ▶ **Thermo Fisher Connect Region**.
2. Select the appropriate region.
3. Touch **OK**.

Set the date and time (Administrator only)

1. In the home screen, touch  **Settings** ▶ **Instrument Settings** ▶ **Date/Time**.
2. Select a time zone from the dropdown list.
3. Select a date format.
 - a. Touch **Date Format**, then select the preferred date format.
 - b. Touch **Next**, touch the date field, then enter the date.
 - c. Touch **Enter**, then touch **Done**.
4. Select a time format.
 - a. Touch **Time Format**.
 - b. Slide the control to select a 12-hour or 24-hour clock.
 - c. Touch **Next**, touch the time field, then enter the time.
 - d. Touch **Enter**, then touch **Done**.
5. Touch **Done**.



Configure the network

IMPORTANT! Configure the instrument for either wired connection or wireless connection but not both.

 "Set up a wired connection" on page 35

 "Set up a wireless connection" on page 35

Set up a wired connection



1. In the home screen, touch  **Settings** ▶ **Instrument Settings** ▶ **Network Connection** ▶  **Wired**.
2. In the **Network Configuration** screen, touch a radio button to connect to a network either by **DHCP** or by a **Static IP** address.

Option	Action
Automatic	Touch DHCP .
Manual	<ol style="list-style-type: none"> a. Touch Static IP. b. Enter the IP address for the instrument, the Subnet Mask, the Default Gateway, and <i>(optional)</i> the Primary DNS Server and the Secondary DNS Server. Addresses are in the form of X.X.X.X, where each X is a number from 0 to 255.

Note: Ask your system administrator if the IP address is assigned statically or dynamically. For static addresses, you need to know the **IP address** for the instrument, the **Subnet Mask**, and the **Default Gateway**.

3. Touch **OK**.

Set up a wireless connection

1. In the home screen, touch  **Settings** ▶ **Instrument Settings** ▶ **Network Connection** ▶  **Wireless** to display a list of the available networks.
2. Select a network or touch **Join other network**, enter the network password, then touch **Enter**.
If you select **Join other network**, enter the network name and security type.
3. Touch **Join** to continue.
4. In the **Network Connection Complete** screen, touch **Next**.
5. Touch **OK**.
6. In the **Network Configuration** screen, edit the Network details or touch **Done**.

Restore factory defaults

This procedure can only be performed by an Administrator.

IMPORTANT! Back up the instrument before restoring factory defaults (see “Backup or restore the instrument” on page 77).

1. In the home screen, touch  **Settings** ▶ **Instrument Settings** ▶ **Restore Factory Defaults**.
2. Touch **Restore Factory Defaults**.
3. Power **Off**, then power **On** the instrument to apply the change.
 - Instrument profiles and files stored on the instrument are deleted, including all EDS files and any custom dye calibrations.
 - The most recent valid ROI/Uniformity, Background, and system dye calibrations are not deleted.

After restoring factory defaults, perform initial start-up tasks. See “Initial start-up” on page 27.

Select a language

1. In the home screen, touch  **Settings** ▶ **Instrument Settings** ▶ **Language**.
2. Touch the desired language selection.
3. Touch **OK**.

Learn about the instrument

In the home screen, touch  **Settings** ▶ **About Instrument** to access the following information.

“View instrument specifications” on page 36

“View and export the License Agreement” on page 37

View instrument specifications

In the home screen, touch  **Settings** ▶ **About Instrument** ▶ **About Instrument** to access the following information.

- Model Name
- Wired IP Address
- Wireless IP Address
- Instrument Serial Number
- Block Serial Number
- UUID
- Firmware Version
- Thermal Block Controller

- Instrument Server
- User Interface

View and export the License Agreement

1. In the home screen, touch  **Settings** ▶ **About Instrument** ▶ **License Agreement** to view the license agreement.
2. Touch **Export** to export the license agreement.
3. Touch **Done**.

Manage home screen notifications

1. In the home screen, touch  **Settings** ▶ **Notifications** to view and manage **Home Screen Notifications**.
2. Slide the control **On** or **Off** to enable or disable individual notifications, or touch **Clear All** to remove all notifications.
3. Touch **Close**.

Manage maintenance, service, and calibrations

In the home screen, touch  **Settings** ▶ **Maintenance and Service** to access the following functions.

“Update instrument software (Administrator only)” on page 37

“Enable remote instrument monitoring (Administrator only)” on page 38

“View instrument statistics” on page 38

Chapter 5, “Calibrate and verify instrument performance”

“View instrument logs” on page 38

“Backup or restore the instrument” on page 77

“Prepare the instrument to store, move, or ship” on page 82

Update instrument software (Administrator only)

1. In the home screen, touch  **Settings** ▶ **Maintenance and Service** ▶ **Software Update**.
2. Select the location of the update files.
3. When prompted, confirm your request to update the software.

Enable remote instrument monitoring (Administrator only)

1. In the home screen, touch  **Settings** ▶ **Maintenance and Service** ▶ **Monitoring**.
2. Configure the instrument monitoring settings.

Option	Description
Remote Monitoring Service	Slide the control On to enable the Remote Monitoring Service . Enabling the Remote Monitoring Service allows the instrument to automatically notify Thermo Fisher Scientific support teams in real time of potential instrument issues. The service monitors and sends general <i>instrument</i> data, but the service does not monitor or send <i>customer</i> data.
Thermo Fisher™ Connect Monitor	Slide the control On to enable users to access real-time monitoring of amplification plots from the Thermo Fisher™ Connect dashboard (cloud-based platform).





3. Touch **OK**.

View instrument statistics

In the home screen, touch  **Settings** ▶ **Maintenance and Service** ▶ **Instrument Statistics** to view the following statistics.

- Disk Space Remaining (MB)
- Block Cycle Count
- Block Degrees Climbed
- LED Life
- RNase P Status

View instrument logs

1. In the home screen, touch  **Settings** ▶ **Maintenance and Service** ▶ **Log**.
2. Touch **Instrument Run Log** to view the log records.
3. (Optional) Touch a category on the left to filter the log table by event type.
4. (Optional) Touch an individual log record to view details.
5. (Optional) Export log records:
 - Touch **Export** ▶  **USB**.
 - Touch **Export** ▶  **Cloud**, then touch **Export**.
 - Touch **Export** ▶  **Network**.

Manage Users

In the home screen, touch  **Settings** ▶ **Manage Users** to access the following functions.

“Require instrument profile sign-in (Administrator only)” on page 39.

“Manage the Sign Out Timer (Administrator only)” on page 39.

“Manage all instrument profiles (Administrator only)” on page 40.

Require instrument profile sign-in (Administrator only)

1. In the home screen, touch  **Settings** ▶ **Manage Users** ▶ **Sign In Required**.
2. Slide the control **On**.
Only signed-in users are allowed to access the instrument for any task, including access to **Settings**.
3. Touch **Done**.

Manage the Sign Out Timer (Administrator only)

1. In the home screen, touch  **Settings** ▶ **Manage Users** ▶ **Sign Out Timer**.
2. Touch the **Edit Time** field, then enter the desired duration of inactivity before automatic user sign out.
3. Touch **Enter**, then touch **Done**.

Manage instrument profiles

Note: An instrument profile is a user account specifically for the instrument. It is not related to any other user account for the system or software.

To	See
Create a profile	<ul style="list-style-type: none"> • “Create an administrator instrument profile during initial start-up” on page 28 • “Create a new instrument profile” on page 29
Configure a profile	<ul style="list-style-type: none"> • “Link an instrument profile to Thermo Fisher™ Connect” on page 40 • “Edit an instrument profile” on page 39
View or manage all profiles	<ul style="list-style-type: none"> • “Manage all instrument profiles (Administrator only)” on page 40

Edit an instrument profile

1. In the home screen, touch  **My Profile**.

Note: Administrators can also navigate to this screen by touching  **Settings** ▶ **Manage Users** ▶ **Manage Profiles**.

2. Touch **Edit**.
3. Select the fields to edit, then make changes.
4. Touch **Done**.

Manage all instrument profiles (Administrator only)

1. In the home screen, access the **All Profiles** tab.
 - Touch 👤 **My Profile** ▶ **All Profiles**.
 - Touch ⚙️ **Settings** ▶ **Manage Users** ▶ **Manage Profiles** ▶ **All Profiles**.

A list of users, the date the profile was created, and the user type displays.

2. Select the instrument profile to edit.
3. Edit the profile.
 - To delete the profile, touch **Delete profile** ▶ **Delete**.
 - To reset the PIN, touch **Reset PIN** ▶ **Reset**.
 - The user will be directed to enter a new PIN at the next sign in.
 - To enable or disable administrative privileges, slide the control to **Administrator** or **Standard**, respectively.
4. Touch **Done**.

Link an instrument profile to Thermo Fisher™ Connect

Linking your instrument profile to Thermo Fisher™ Connect cloud-based platform allows you to access the following functions:

- View an instrument status from the cloud.
- Download templates from your cloud storage to the instrument.
- Transfer run data from the instrument to your cloud storage.

To link an instrument profile to Thermo Fisher™ Connect, see the following sections:

- “Recommended order to set up profiles” on page 41
- “Overview of local instrument profiles and Thermo Fisher™ Connect profiles” on page 41
- “Thermo Fisher™ Connect instrument profile roles and functions” on page 42
- “Link the instrument to your Thermo Fisher™ Connect account” on page 42
- “Link a local profile to a Thermo Fisher™ Connect profile” on page 43
- “Unlink a Thermo Fisher™ Connect account” on page 45
- “If you link when you are signed in to the instrument” on page 45
- “Change the PIN for a Thermo Fisher™ Connect profile” on page 46

Recommended order to set up profiles

Task	Description
Create a profile for the instrument administrator.	The first profile on the instrument becomes the instrument administrator. See “Create an administrator instrument profile during initial start-up” on page 28.
Select a Thermo Fisher™ Connect administrator.	A Thermo Fisher™ Connect administrator is distinct from an instrument administrator. The first Thermo Fisher™ Connect profile to be linked to the instrument is automatically assigned the role of a Thermo Fisher™ Connect administrator. It is recommended that the first Connect profile to be linked is the one that should be a Thermo Fisher™ Connect administrator. The roles can be updated at a later time on the Thermo Fisher™ Connect platform.
Each person creates a profile.	Create a local instrument profile. Thermo Fisher™ Connect -enabled features are not available.
	(Optional) Link a local instrument profile to a Thermo Fisher™ Connect profile. Sign in with a Thermo Fisher™ Connect profile. Thermo Fisher™ Connect-enabled features are available.
Assign additional instrument administrators.	Any of the profiles can be assigned the role of instrument administrator. The local profile must be created first or the Thermo Fisher™ Connect profile must be linked first.

Overview of local instrument profiles and Thermo Fisher™ Connect profiles

- Local instrument profile
 - Experiment template files and data files are stored on the instrument.
 - Experiment template files and data files can be transferred to the desktop software.
 - Email notifications are not available.
 - Separate profiles are required for each instrument if multiple instruments are used.
- Thermo Fisher™ Connect profile
 - Experiment template files and data files are stored on the instrument.
 - Experiment template files and data files can be transferred to the Thermo Fisher™ Connect platform or the desktop software.
 - Email notifications are available.
 - The same profile can be used for multiple instruments.

Thermo Fisher™ Connect instrument profile roles and functions

The first user who links their local instrument profile to their Thermo Fisher™ Connect account is assigned a Thermo Fisher™ Connect profile with administrator role.

Instrument profile	Location	Functions allowed
Standard	Thermo Fisher™ Connect	<ul style="list-style-type: none"> • Create, save, open, import, and run template files • Create and modify run settings • View and export data files
Administrator	Thermo Fisher™ Connect	<p>All the permissions of a local administrator profile, plus the following functions performed in Thermo Fisher™ Connect:</p> <ul style="list-style-type: none"> • See a list of all the Thermo Fisher™ Connect profiles that are linked to the instrument • Assign Thermo Fisher™ Connect administrator roles to one or more users • Remove a user from an instrument • Disconnect the instrument from Thermo Fisher™ Connect • Change the instrument name

Test the connection to the Thermo Fisher™ Connect platform

1. In the home screen, tap  **(Settings)** ▶ **Maintenance and service** ▶ **Connect services**.
The **Connect Services** screen is displayed.
2. Tap **Test connection**.
If the connection can be established, **You are able to connect to the Connect platform** will be displayed.
If the connection cannot be established, **Unable to connect** will be displayed.
3. Tap **Close**.

Link the instrument to your Thermo Fisher™ Connect account

This section describes using your Thermo Fisher™ Connect account when you use the instrument for the first time.



The first time you use your Thermo Fisher™ Connect account on an instrument, you will be prompted to create a four-digit numerical PIN. This PIN is to use when signing in to the instrument with your Thermo Fisher™ Connect account. It will apply to all other instruments when you use your Thermo Fisher™ Connect account. This does not change the password when signing in to your Thermo Fisher™ Connect account on a browser.

The first time the instrument is used with a Thermo Fisher™ Connect account, a region must be selected.

1. In the **Sign In** screen, tap **Get started** ▶ **Create a local instrument file** ▶ **Connect to your Thermo Fisher™ Connect** account.
2. (Optional) Select the appropriate region.

Option	Description
China	For users in China
U.S.	For users in any country other than China

3. Tap a connection option.

Option	Action
 Mobile devices	<p>Note: Before selecting this option, install and sign in to the Thermo Fisher™ Connect application on your mobile device.</p> <hr/> <p>On the instrument:</p> <ol style="list-style-type: none"> a. Tap  Mobile devices. b. Hold the camera on your mobile device over the QR code that is displayed on the touchscreen. c. Tap Close.
 PC	<p>A link code is displayed on the instrument.</p> <p>On a computer:</p> <ol style="list-style-type: none"> a. Access the Thermo Fisher™ Connect platform. b. Click Add instrument. c. Select QuantStudio. d. Enter the link code.

4. (Optional) In the **Enter PIN** screen, tap the **PIN (4 digits required)** field, enter a four-digit numerical PIN, then tap **Enter**.
 Tap the **Show PIN** checkbox to show or hide the PIN.
5. (Optional) Tap the **Confirm PIN** field, enter the four-digit numerical PIN again, then tap **Enter**.
6. Tap **Done**.

Link a local profile to a Thermo Fisher™ Connect profile

This section describes linking a local instrument profile to a Thermo Fisher™ Connect profile, if a local instrument profile was created first.

The first time you use your Thermo Fisher™ Connect account on an instrument, you will be prompted to create a four-digit numerical PIN. This PIN is to use when signing in to the instrument with your Thermo Fisher™ Connect account. It will apply to all other instruments when you use your Thermo Fisher™

Connect account. This does not change the password when signing in to your Thermo Fisher™ Connect account on a browser.



The first time the instrument is used with a Thermo Fisher™ Connect account, a region must be selected.

(Optional) Test the connection, see “Test the connection to the Thermo Fisher™ Connect platform” on page 42.

1. In the home screen, tap  (**Profile**).
The **My Profile** screen is displayed.
2. Tap **Connect** ▶ **Link Account**.
The **Connect to Connect Platform** screen is displayed.
3. (Optional) Select the appropriate region.

Option	Description
China	For users in China
U.S.	For users in any country other than China

4. Tap a connection option.



Option	Action
 Mobile devices	<p>Note: Before selecting this option, install and sign in to the Thermo Fisher™ Connect application on your mobile device.</p> <hr/> <p>On the instrument:</p> <ol style="list-style-type: none"> a. Tap  Mobile devices. b. Hold the camera on your mobile device over the QR code that is displayed on the touchscreen. c. Tap Close.
 PC	<p>A link code is displayed on the instrument.</p> <p>On a computer:</p> <ol style="list-style-type: none"> a. Access the Thermo Fisher™ Connect platform. b. Click Add instrument. c. Select QuantStudio. d. Enter the link code.

5. (Optional) In the **Enter PIN** screen, tap the **PIN (4 digits required)** field, enter a four-digit numerical PIN, then tap **Enter**.
Tap the **Show PIN** checkbox to show or hide the PIN.
6. (Optional) Tap the **Confirm PIN** field, enter the four-digit numerical PIN again, then tap **Enter**.
7. Tap **Done**.

Unlink a Thermo Fisher™ Connect account

Unlinking a Thermo Fisher™ Connect is done from the Thermo Fisher™ Connect platform on your computer.

For more information about unlinking a Thermo Fisher™ Connect account, see “If you link when you are signed in to the instrument” on page 45.

1. Sign in to your account on the desktop Thermo Fisher™ Connect platform.
2. In the left pane, click  **(Instrument)**.
3. Select the instrument, then click  **Disconnect**.
4. Tap **Confirm**.

If you link when you are signed in to the instrument

In this scenario, your local instrument profile name is created manually on the instrument before you link. Your local instrument profile name differs from your Thermo Fisher™ Connect instrument profile name.

Phase	Steps that occur
Before you link:	<ul style="list-style-type: none"> • You enter your local instrument profile name in the Sign In screen. • Your local instrument profile (<i>UserABC</i>) is displayed in the home screen of the instrument. • All plates and results that you create are accessible only when you are signed in with your local instrument profile.
When you link:	<ul style="list-style-type: none"> • You link your local instrument profile (see “Link a local profile to a Thermo Fisher™ Connect profile” on page 43). • If this is the first time you link, a Thermo Fisher™ Connect instrument profile is created using the <i>FirstNameLastInitial</i> of the user name from your thermofisher.com account. Example: <i>User1@thermofisher.com</i> First name is <i>User</i>, Last name is <i>Gray</i>. Thermo Fisher™ Connect account username is <i>User G</i>. • Your local instrument profile (<i>UserABC</i>) is linked to your Thermo Fisher™ Connect account (<i>User1@thermofisher.com</i>). • Your Thermo Fisher™ Connect instrument profile (<i>User G</i>.) replaces your local instrument profile.
After you link:	<ul style="list-style-type: none"> • Your Thermo Fisher™ Connect instrument profile (<i>User G</i>.) and  is displayed in the home screen of the instrument. • Plate files and data files from your local instrument profile can be transferred to Thermo Fisher™ Connect. • New plate files and data files are saved under your Thermo Fisher™ Connect instrument profile.

(continued)

Phase	Steps that occur
If your Thermo Fisher™ Connect account is unlinked:	<ul style="list-style-type: none"> • Your local instrument profile (<i>UserABC</i>) is displayed in the home screen of the instrument. • Plate files and data files that were saved under your Thermo Fisher™ Connect instrument profile are accessible under your local instrument profile. • Plate files and data files are saved under local instrument profile and can be copied to Thermo Fisher™ Connect (see “Manage templates (EDT files)” on page 26 and “Transfer EDS files from the instrument home screen” on page 25). • Your local instrument profile name (<i>UserABC</i>) is available for selection in the Sign In screen.

Change the PIN for a Thermo Fisher™ Connect profile

This section describes changing a PIN for a Thermo Fisher™ Connect profile. To change a PIN for a local instrument profile, see “Manage all instrument profiles (Administrator only)” on page 40.

1. Sign in to Thermo Fisher™ Connect on a browser.
2. Click **Update PIN number**.
3. In the **Update PIN number** dialog box, enter a new PIN, then enter the new PIN a second time to confirm it.
4. Click **Send**.

The 4-digit PIN to sign in to instruments with your Thermo Fisher™ Connect profile is updated. This change applies to all of the instruments that you access with your Thermo Fisher™ Connect profile.

4

Create and run experiments on the instrument

- Workflow 47
- Run an experiment 48
- Edit an experiment before starting a run 50
- View, pause, or stop a run 55
- Transfer EDS files from the instrument home screen 56

Workflow

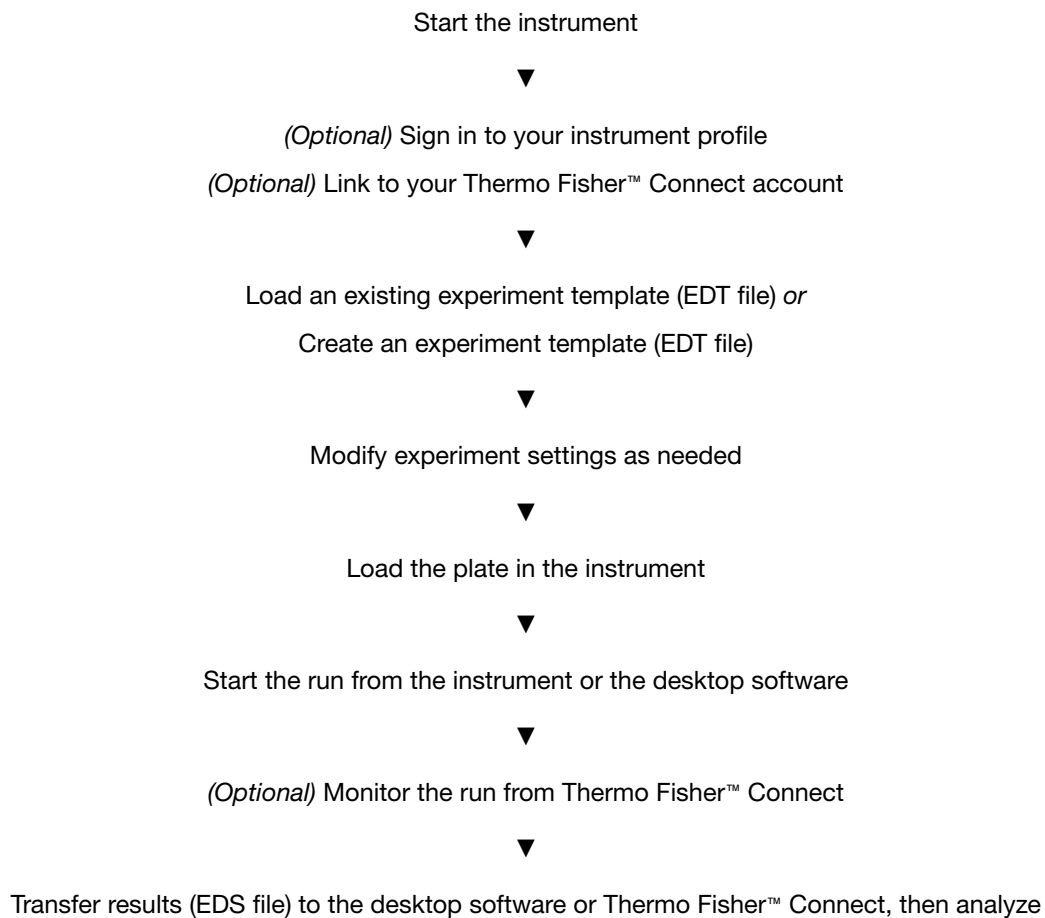





Run an experiment

Create and run an experiment from a template

1. In the home screen, touch  **Open Template**.
2. (Optional) Touch a category in the left column.
3. Touch the file name.
4. (Optional) Enter or edit template properties, including **Run File Name** (EDS file name), **Plate Barcode**, **Reagent Information**, and **Data Destination** (see “Enter or edit template properties”).
5. (Optional) Edit the run method (see “Edit the run method” on page 51).
 - Add, remove, or edit a step, stage, melt curve, or data collection point.
 - Adjust the heated cover temperature, sample volume, or number of cycles.
 - Configure ramp rate and pause settings.
6. (Optional) Define plate wells with sample names and view **Well ID**, **Targets**, or **Dyes** (see “Define, assign, and view well details”).
7. Load a plate into the instrument (see “Load and unload a plate in the instrument” on page 23).
8. Touch **Start Run**.
When prompted, confirm that you inserted a plate.

Note: To disable this reminder, select **Do not show again** or select  **Settings** ▶ **Insert Plate Reminder** in the home screen.

Run an experiment from a saved file

1. In the home screen, touch  **Load Experiment**.
2. Touch the appropriate icon to navigate to your file location.
 - For files saved to the guest profile, touch  **My Instrument** ▶ **Public**.
 - For pre and post read files, touch  **My Instrument** ▶ **Post Read**.
3. Touch the file name.
4. (Optional) Manage templates in either  **USB** or  **My Instrument** (see “Manage templates (EDT files”).
5. (Optional) Enter or edit template properties, including **Run File Name** (EDS file name), **Plate Barcode**, **Reagent Information**, and **Data Destination** (see “Enter or edit template properties”).

6. (Optional) Edit the run method (see “Edit the run method” on page 51).
 - Add, remove, or edit a step, stage, melt curve, or data collection point.
 - Adjust the heated cover temperature, sample volume, or number of cycles.
 - Configure ramp rate and pause settings.
7. (Optional) Define plate wells with sample names and view **Well ID**, **Targets**, or **Dyes** (see “Define, assign, and view well details”).
8. Load a plate into the instrument (see “Load and unload a plate in the instrument” on page 23).
9. Touch **Start Run**.
When prompted, confirm that you inserted a plate.

Note: To disable this reminder, select **Do not show again** or select  **Settings** ▶ **Insert Plate Reminder** in the home screen.

Repeat the last instrument run

This feature applies only to runs started from the instrument and is not available for runs started from the desktop software. If you are signed-in, this feature applies to the last run from your instrument profile.

1. In the home screen, touch  **Run Last**.
2. (Optional) Enter or edit template properties, including **Run File Name** (EDS file name), **Plate Barcode**, **Reagent Information**, and **Data Destination** (see “Enter or edit template properties”).
3. (Optional) Edit the run method (see “Edit the run method” on page 51).
 - Add, remove, or edit a step, stage, melt curve, or data collection point.
 - Adjust the heated cover temperature, sample volume, or number of cycles.
 - Configure ramp rate and pause settings.
4. (Optional) Define plate wells with sample names and view **Well ID**, **Targets**, or **Dyes** (see “Define, assign, and view well details”).
5. Load a plate into the instrument (see “Load and unload a plate in the instrument” on page 23).
6. Touch **Start Run**.
When prompted, confirm that you inserted a plate.

Note: To disable this reminder, select **Do not show again** or select  **Settings** ▶ **Insert Plate Reminder** in the home screen.



Edit an experiment before starting a run

Enter or edit template properties

Access a template (EDT file). For more information, see the following sections:

- “Create and run an experiment from a template” on page 48.
- “Run an experiment from a saved file” on page 48.
- “Repeat the last instrument run” on page 49.

In the **Properties** screen, touch **Edit** to enter or edit template properties.

- Edit the file name for the EDS file for the run.
 - a. Touch the **Run File Name** field.
 - b. Enter the name for the EDS file, then touch **Done**.
- Enter a plate barcode.
 - a. Touch the **Plate Barcode** field.
 - b. Enter or scan the plate barcode, then touch **Done**.
- Record reagents and their expiration dates.
 - a. Touch  **Reagent Information**.
 - b. Touch **Add**, or touch an existing reagent, then touch **Edit** or **Delete**.
 - c. Touch the **Name**, **Type**, **Lot #**, **Reagent Barcode**, **Part #**, or **Expiration Date** field to enter individual reagent information.
 - d. Touch **Done**.
- Automatically transfer run data (EDS file) when an instrument run ends.
 - a. Touch  **Data Destination**.
 - b. Touch the appropriate icon to select a data destination.
 - c. Under the desired data destination, select **Automatically transfer experiment**.
 - d. Touch **Done**.
- Enter a comment.
 - a. Touch **Comments**.
 - b. Enter text, then touch **Done**.

Scan a barcode using the optional barcode scanner

The instrument is compatible with an optional Handheld Barcode Scanner (Cat. No. [4488442](#), purchased separately). The barcode scanner reads Code 128 (alphanumeric), which supports 128 ASCII character barcodes.

1. Click the **Barcode** field.
2. Hold the scanner 20–30 cm away from a plate or container label and aim at the center of the barcode, then press the trigger.
3. Slowly move the scanning beam across the barcode until the scanner emits a high-pitched tone.

When the scanner scans a barcode, it automatically transmits the following information:

- Transmits the alphanumeric equivalent of the barcode to the barcode field.
- Transmits other reagent information (Lot #, Part #, Expiration Date, etc.)

For more information about the hand-held barcode scanner, see the user documentation provided with the barcode scanner.

Edit the run method

Access a template (EDT file). For more information, see the following sections.

- “Create and run an experiment from a template” on page 48.
- “Run an experiment from a saved file” on page 48.
- “Repeat the last instrument run” on page 49.

For an overview of the method as it is graphically represented on the touchscreen, see “Method elements” on page 52.

1. In the **Method** screen, touch **Edit**.
2. Touch a field, enter changes, then touch **Enter**.

Note: Touch-drag \equiv to quickly increase or decrease a step temperature.

3. Touch “**Manage steps, stages, melt curves, and data collection points**” to add or remove a step, stage, melt curve, or data collection point.

Note: The **Manage Steps** screen also provides access to configuring **Ramp Rates** and **Add Pause** settings. See “Configure ramp rates and pause settings” on page 54.

Method elements



- | | |
|-----------------------------|----------------------------------|
| ① Method tab | ⑥ Number of cycles for the stage |
| ② Heated cover temperature | ⑦ Temperature for the step |
| ③ Reaction volume | ⑧ Hold time for the step |
| ④ Stage of thermal protocol | ⑨ Data collection point |
| ⑤ Step within a stage | |

Manage steps, stages, melt curves, and data collection points

Add or remove a step, stage, melt curve, or data collection point using the **Manage Steps** option. You can also configure ramp rates and pause settings from the **Manage Steps** screen (see “Configure ramp rates and pause settings” on page 54).

- In the **Method** screen, touch **Edit** ▶ **Manage Steps**.

Option	Procedure
Add a step	<ol style="list-style-type: none"> 1. Touch Add/Remove steps ▶ Add steps. 2. Touch + on the left or right border of a step to add a step before or after the step, respectively. 3. Enter parameters for the new step, then touch Enter. 4. Touch Done.
Remove a step	<ol style="list-style-type: none"> 1. Touch Add/Remove steps ▶ Remove steps. 2. Touch — on the step to be removed, then touch Done.

(continued)

Option	Procedure
Add a stage	<ol style="list-style-type: none"> 1. Touch Add/Remove stages ▶ Add stages. 2. Touch + on the left or right border of a stage to add a stage before or after the stage, respectively. 3. Edit parameters of the new stage in the Method screen. See “Edit the run method” on page 51. 4. Touch Done.
Remove a stage	<ol style="list-style-type: none"> 1. Touch Add/Remove stages ▶ Remove stages. 2. Touch — on the stage to be removed, then touch Done.
Add a melt curve	<ol style="list-style-type: none"> 1. Touch Melt curves ▶ Add melt curve. 2. Touch + on the left or right border of a step to add a melt curve before or after the step, respectively. 3. Select Continuous or Step and hold. 4. Touch melt curve parameters to edit, then touch Done. 5. Touch Done. <p>Note: Depending on the experiment type, there can be restrictions on the addition or placement of melt curves.</p>
Remove a melt curve	<ol style="list-style-type: none"> 1. Touch Remove melt curve. 2. Touch — on the melt curve to be removed, then touch Done.
Add or remove data collection points	<ol style="list-style-type: none"> 1. Touch Data collection location. 2. Touch  to switch data collection on or off.

Configure ramp rates and pause settings

- In the **Method** screen, touch **Edit** ▶ **Manage Steps** ▶ **Advanced Options**.

Option	Procedure
Edit Ramp Rates	<ol style="list-style-type: none"> 1. Touch Ramp Rates. 2. Touch the ramp rates fields. 3. Touch Enter. 4. (Optional) Edit additional steps, then touch Done.
Add a pause	<ol style="list-style-type: none"> 1. Touch Add Pause. 2. Touch in a stage. 3. Enter the pause temperature, and the cycle after which the pause will occur. 4. Touch Enter. 5. The pause is represented by a P in the corner of the stage. 6. Touch Done.

Define, assign, and view well details

- Access a template (EDT file). For more information, see the following sections.
 - “Create and run an experiment from a template” on page 48.
 - “Run an experiment from a saved file” on page 48.
 - “Repeat the last instrument run” on page 49.
- In the **Plate** screen, define, assign, and view well details.

Option	Procedure
Define and assign samples in the plate layout view	<ol style="list-style-type: none"> 1. Touch ⋮. 2. Touch Manage or touch an individual well. 3. Touch the Samples subtab. 4. Select one or more wells, then touch Edit. 5. Enter sample names for the selected wells, then touch Done.
Define and assign samples in the well table view	<ol style="list-style-type: none"> 1. Touch ≡. 2. Touch Edit to edit sample names for individual wells. 3. Touch a sample name field, enter a new name, then touch Done.
View target information	<ol style="list-style-type: none"> 1. Touch ⋮. 2. Touch Manage or touch an individual well. 3. Touch the Targets subtab. 4. Touch Details to view target information, then touch Done.

- Touch **Done** to return to the **Plate** tab.

View, pause, or stop a run

Do any of the following actions during an instrument run.

- View real-time data and plots (see “View real-time data and plots on the instrument touchscreen” on page 55).
- Adjust the display of real-time plots (see “Adjust the display of real-time plots on the instrument touchscreen” on page 55).
 - Touch **>** or swipe left once to view real-time run method information or to edit the number of cycles.
 - Touch **>** or swipe left twice to view real-time data and plots.
- Pause or stop an instrument run (see “Pause or stop an instrument run” on page 55).

View real-time data and plots on the instrument touchscreen

1. In the instrument home screen, during an instrument run, touch **>** or swipe left twice.
2. Touch **Well details**.
3. Touch **Samples**, **Targets**, or **Tasks** to select a graphical representation of each selection.
4. Touch **Close** to return to the home screen.

Adjust the display of real-time plots on the instrument touchscreen

1. In the instrument home screen, during an instrument run, touch **>** or swipe left twice to view real-time data and plots.
2. Touch **Zoom**.
3. Touch **🔍** or **🔍** to zoom in or out.
4. Touch the arrows to pan left, right, up, or down on the graph.
5. Touch **Close** to return to the default view.

Pause or stop an instrument run

1. In the home screen, during an instrument run, touch **>** or swipe left once to view real-time run method information.
2. Stop or pause the run.
 - Touch **Stop Run**.
 - Touch **Pause**, then enter a pause temperature.
3. (Optional) After pausing a run, touch **Edit** to change the number of cycles.

4. (Optional) After pausing a run, touch **Unlock drawer** to access the plate.



CAUTION! PHYSICAL INJURY HAZARD. During instrument operation, the plate temperature can reach 100°C. If you want to access the plate during a run pause, enter room temperature as the pause temperature and allow the plate to cool to room temperature before handling.

Lock the touchscreen during a run

After you have started a run, you can lock the touchscreen so that other users cannot interfere with instrument operation.

Note: You must be signed-in to use this feature.

1. Lock the touchscreen.
 - a. In the home screen, touch  **My Profile**.
 - b. Touch **Lock Screen**, then touch **Lock**.
2. Unlock the touchscreen.
 - a. Touch anywhere on the touchscreen.
 - b. Touch the **PIN Code** field, then enter your PIN.

Note: The touchscreen automatically unlocks when the run is complete.

Transfer EDS files from the instrument home screen

1. In the home screen, when a run ends, touch **Transfer File**.
2. Select the data destination for the EDS file.
3. Navigate to and select a folder.
4. Touch **OK**.
5. Touch **Transfer**.

Note: Touch  **Settings** ▶ **Run History** to transfer EDS files at any time.



Calibrate and verify instrument performance

■ Calibration and verification schedule	57
■ Calibration descriptions	58
■ View the calibration status and set reminders	59
■ Perform ROI/uniformity, background, and dye calibrations	60
■ Perform instrument verification using RNase P plates	65
■ Calibrate custom dyes	70
■ Calibrate for a custom melt curve experiment	75

Calibration and verification schedule

The instrument is factory-calibrated and does not require calibration at installation. To help ensure optimal performance, perform calibrations at the recommended frequency.

Note: After instrument installation, we recommend performing instrument verification using the provided RNase P plate.

IMPORTANT! Perform calibrations and instrument runs under the environmental conditions that are specified in “Environmental requirements” on page 97. Exposure to extreme temperatures can adversely affect the instrument performance and shorten the life span of the instrument components.

To set the calibration frequency for the instrument, touch  **Settings** ▶ **Maintenance and Service** ▶ **Calibrations** ▶ **History and Reminders** ▶ **Edit** ▶ **Exp interval** field.

Calibration	Recommended frequency
ROI/Uniformity	<ul style="list-style-type: none">• Every two years (recommended)• Always perform new Background and Dye calibrations after an ROI/Uniformity calibration. <p>Note: Performing an ROI/Uniformity calibration invalidates all other calibrations.</p>

(continued)

Calibration	Recommended frequency
Background	<ul style="list-style-type: none"> • Every two years (recommended) • Background calibration can also be performed, as needed: <ul style="list-style-type: none"> – To check for contamination (depends on usage and laboratory conditions). – To obtain the most accurate data for the removal of background fluorescence. <p>Note: Performing a Background calibration does <i>not</i> invalidate any other calibration.</p>
Dye	<ul style="list-style-type: none"> • Every two years (recommended) • During a Dye calibration, only the dyes on the given spectral calibration plate are calibrated. <p>Note: Performing a Dye calibration for a given dye plate does <i>not</i> invalidate any other calibration.</p>
RNase P instrument verification	<ul style="list-style-type: none"> • After installing or moving the instrument • After performing instrument calibrations (recommended) • As needed to confirm instrument performance

Note: To prepare custom dye plates and to perform custom calibrations, see “Calibrate custom dyes” on page 70.

Calibration descriptions

Calibration description and purpose	Pass Criteria
ROI/Uniformity	
<ul style="list-style-type: none"> • The software captures images for each optical filter. • The software uses calibration data to map the increase in fluorescence to the plate wells during subsequent runs and to evaluate well-to-well consistency of the signals. 	<p>The image for each filter distinguishes all wells of the plate.</p> <p>Each well in the image is distinct.</p>
Background	
<ul style="list-style-type: none"> • The software captures background images for each optical filter in the absence of sample and reagent, and it checks that the fluorescence from each well is below a fluorescence threshold. • The software uses calibration data to remove background fluorescence during a run. <p>Note: You can also run this calibration to determine if contamination is related to the sample block or the plate.</p>	<p>The plate images for all filters are free of abnormal fluorescence.</p>

(continued)

Calibration description and purpose	Pass Criteria
Dye	
<ul style="list-style-type: none"> The software extracts a spectral profile for each dye standard, then produces a set of spectral profiles plotted as fluorescence vs filter. The software uses calibration data to characterize and distinguish the individual contribution of each dye in the total fluorescence signals collected by the instrument. 	Dye spectra peak within the same filter as their group.

View the calibration status and set reminders

View calibration status and set reminders in the instrument

- In the home screen, touch  **Settings** ▶ **Maintenance and Service** ▶ **Calibrations** ▶ **History and Reminders**.
- In the **Calibration Reminders** screen, view the status of each calibration type.
- (Optional) Touch a calibration row to view the history of that specific calibration type, then touch **Done**.
- Touch **Edit** to set the calibration reminder settings. For each calibration type:
 - Slide the control **On** to enable the calibration reminder.
 - Edit the **Exp interval** and **Remind me** fields.
 - Touch **Save**.
- (Optional) To transfer the calibration report, touch **Export** then follow the directions on the screen.
- Touch **Done**.

View calibration status and set reminders in Thermo Fisher™ Connect

Note: The calibration reminders feature requires a connection between the instrument and a computer network.

- In Thermo Fisher™ Connect, click  for the **Instrument Connect** page.
- Select any of your registered instruments.

3. In the **Summary** tab:

- Click **+ Calibrations** to view the status of each calibration type.
- (Optional) Click **+ Calibration Reminders** to set the calibration reminder time table and enter the notification email address(es).

Note: More than one email address can receive the calibration reminders.

Note: The settings are automatically saved.

- (Optional) In the **Downloads** section, click **Maintenance Summary.pdf** to download the calibration status report.

4. In the **Calibrations History** tab:

- View the history of each calibration type.
- (Optional) Click  to download the calibration history report.

Perform ROI/uniformity, background, and dye calibrations

Workflow: Calibration

Note: The ROI and uniformity calibrations use the same calibration plate.

Perform an ROI calibration



Perform a uniformity calibration

You are automatically prompted to perform background calibration.



Perform a background calibration

Perform any time that ROI calibrations are current.



Perform system dye calibrations

Perform any time that ROI and background calibrations are current.



(Optional) Perform custom dye calibrations (“Calibrate custom dyes” on page 70)

Perform any time that ROI and background calibrations are current.

Prepare a calibration plate

Materials required for calibration plate preparation

- Plate(s) for the calibration that you are performing:
 - ROI plate (the same plate is used for ROI and uniformity calibrations)
 - Background calibration plate
 - Dye calibration plates

Note: We recommend calibrating with all Spectral Dye Calibrations Plates available for your block configuration even if you are not using all the dyes in the plates.

Note: Do not discard the packaging for the calibration plates. Each calibration plate can be used up to 3 times if the following conditions are met:

- The plate is stored in its packing sleeve at -15 to -25°C .
 - The plate is used within 6 months after opening.
 - The plate is used before the plate expiry date
-
- Centrifuge with plate adapter; buckets cleaned before use
 - Powder-free gloves
 - Safety glasses

Thaw, vortex, and centrifuge a calibration plate

1. Remove the calibration plate from the freezer, then thaw the plate in its packaging. Keep plates protected from light until you perform the calibration.
 - Thaw each plate for 30 minutes.
 - Use each plate within 2 hours of thawing.

IMPORTANT! Do not remove the plate from its packaging until you are ready to use it. The fluorescent dyes in the wells of calibration plates are photosensitive. Prolonged exposure to light can diminish the fluorescence of the dyes.

2. While wearing powder-free gloves, remove the calibration plate from its packaging and retain the packaging. Do not remove the optical film.
3. Vortex the plate for 5 seconds, then centrifuge at $750\text{--}1,000 \times g$ for 2 minutes.
4. Confirm that the liquid in each well is at the bottom of the well and free of bubbles. If it is not, centrifuge the plate again.

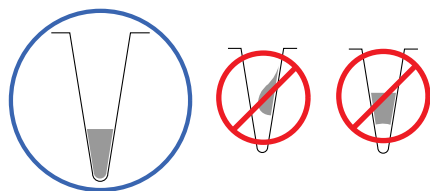

IMPORTANT! Keep the bottom of the plate clean. Fluids and other contaminants on the bottom of the plate can contaminate the sample block and cause an abnormally high background signal.

Perform calibrations

1. In the home screen, select a calibration to perform.

Calibration	Touch
ROI/Uniformity ^[1]	⊛ Settings ▶ Maintenance and Service ▶ Calibrations ▶ ROI and Uniformity
Background ^[2]	⊛ Settings ▶ Maintenance and Service ▶ Calibrations ▶ Custom ▶ Background
Dye	⊛ Settings ▶ Maintenance and Service ▶ Calibrations ▶ Dye

^[1] Automatically followed by Background calibration.

^[2] Initiate via this route if performing Background calibration only.

2. Follow the instructions on the screen to start the calibration.

Note: *Dye calibration only:* Select the **Dye Plate** to run, then touch **Next**.

3. Load the plate into the instrument.
4. Touch **Start**.
5. When the run is complete and the screen displays **Calibration Complete**, touch **View Results** to check the calibration status.

Calibration status	Action
Passed	Touch Next to proceed to the next required calibration.
Failed	See “Troubleshoot calibration failure” on page 64.

Note: You can view the calibration images only after the ROI/Uniformity and Background calibrations pass.

6. Unload the plate from the instrument.



CAUTION! PHYSICAL INJURY HAZARD. During instrument operation, the plate temperature can reach 100°C. Allow it to cool to room temperature before handling.

7. Return the plate to its original packaging.

Note: Each calibration plate can be used up to 3 times if the following conditions are met:

- The plate is stored in its packing sleeve at –15 to –25°C.
 - The plate is used within 6 months after opening.
 - The plate is used before the plate expiry date
-

View calibration images and transfer results to USB

The instrument performs the ROI, Uniformity, and Background calibrations in sequence. You can view the calibration images after the Background calibration is complete.

1. In the **Calibration Status** screen, touch **Details**.
2. In the **Details** screen, touch a calibration type to view its images and plots.

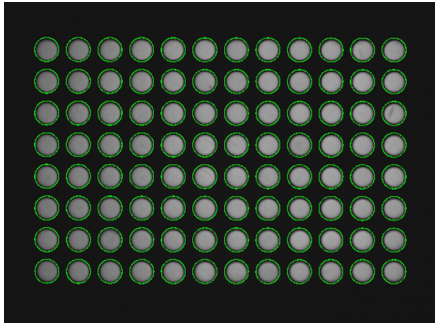
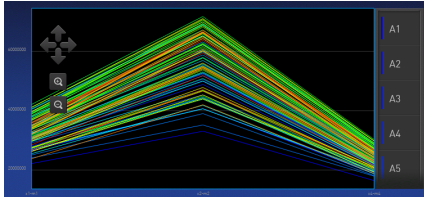
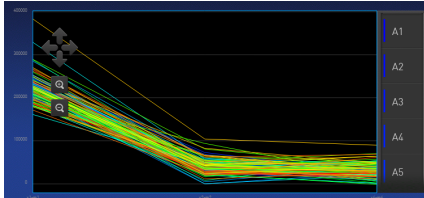
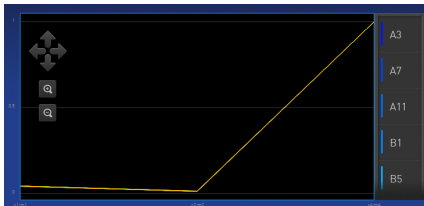
Calibration	Example results indicating successful calibration
ROI Note: Select the desired filter combination from the Filter Set dropdown list.	Green circles around all wells and bright well centers. 
Uniformity	Signals from each well following a uniform trend. 
Background	Few, if any, signals with abnormally high fluorescence. 
Dye	Signals from each well following a uniform trend, and each dye peaks at the correct filter. 

3. In the **Calibration Status** screen, touch **Accept Results** or **Reject Results**.
 Accepting the results saves the calibration data to the instrument and overwrites existing data.
4. (Optional) Touch **Transfer EDS** to transfer the calibration data to a USB.

Troubleshoot calibration failure

Observation	Possible cause	Recommended action
Calibration failed	The plate was improperly prepared.	Ensure the following: <ul style="list-style-type: none"> • The correct plate was used for the calibration performed. • The plate was properly thawed. • The plate was properly centrifuged. • The plate was properly sealed.
	The plate is damaged or contaminated.	Check for damage, improper plate seal, or contamination. Order a replacement plate. If the replacement plate fails, contact Support.
High fluorescence signal in individual wells	Signals that exceed the limit of normal fluorescence may indicate fluorescent contaminants on the plate or the sample block.	See “Identify contamination” on page 64.
Calibration failed but plate is undamaged	The incorrect plate was used for calibration performed.	Use the plate that matches the calibration performed.
	The plate was improperly prepared.	Repeat the calibration with the plate properly prepared.
		If the calibration fails again, order a replacement plate. If the replacement plate fails, contact Support.

Identify contamination

Signals that exceed the limit of normal fluorescence may indicate fluorescent contaminants on the calibration plate or the sample block. Common contaminants include ink residue from permanent pens, powder from disposable gloves, and dust.

1. View the calibration data and note the wells that failed the calibration.
2. Remove the plate from the instrument, rotate the plate 180°, then perform the calibration again.
3. Determine the location of the failed wells again as in step 1.

Position of failed wells	Action
Identical	The sample block is contaminated. Decontaminate the sample block (see page 78).
Reversed	The plate is contaminated. Discard the plate, then perform the calibration using a new calibration plate.

4. If the calibration fails after you decontaminate the sample block and replace the plate, contact Support.

Create a background plate (optional)

Whenever possible, use a background plate listed in Appendix D, “Parts and materials”. These plates contain a buffer that accurately simulates the reagents used for PCR, and, therefore, produces high-quality calibration data.

If a background plate is not available, you can create one as described below.

Required materials:

- MicroAmp™ optical 96-well reaction plate
- Optical adhesive cover or optical flat caps
- Pipettor, 200- μ L (with pipette tips)
- Powder-free gloves
- Safety glasses
- Deionized water

IMPORTANT! Wear powder-free gloves while creating the background plate.

1. Remove a reaction plate from its box and place it on a clean, dry surface.
2. Aliquot 50 μ L of deionized water to each well of the reaction plate.
3. Seal the plate using an optical adhesive cover or optical flat caps.
4. Use the plate for background calibration.

Perform instrument verification using RNase P plates

Instruments are factory-calibrated, so calibration is not necessary for initial installation. However, perform instrument verification:

- After installation and before first use of the instrument.
- After performing instrument calibrations.
- As needed to confirm instrument performance.

The instrument requires valid ROI/uniformity, background, and dye calibrations to perform instrument verification.

Instrument verification description

Purpose	Description	Pass criteria
Confirms the performance of the instrument.	Quantifies the number of copies of the human RNase P gene in samples with known concentrations of the corresponding DNA template.	<p>The instrument passes performance specifications if the following inequality is true and the instrument successfully distinguishes between unknown populations A and B with a statistical confidence level of 99.7%.</p> $[(C_{tA}) - 3(\sigma_{C_{tA}})] > [(C_{tB}) + 3(\sigma_{C_{tB}})]$ <p>where:</p> <ul style="list-style-type: none"> • C_{tA} = Average C_t of unknown population A • $\sigma_{C_{tA}}$ = Standard deviation of unknown population A • C_{tB} = Average C_t of unknown population B • $\sigma_{C_{tB}}$ = Standard deviation of unknown population B

RNase P instrument verification plate

The RNase P plate contains the reagents necessary for the detection and quantitation of genomic copies of the human RNase P gene (a single-copy gene encoding the RNase moiety of the RNase P enzyme). Each well contains: PCR master mix, RNase P primers, FAM™ dye-labeled probe, and a known concentration of human genomic DNA template.

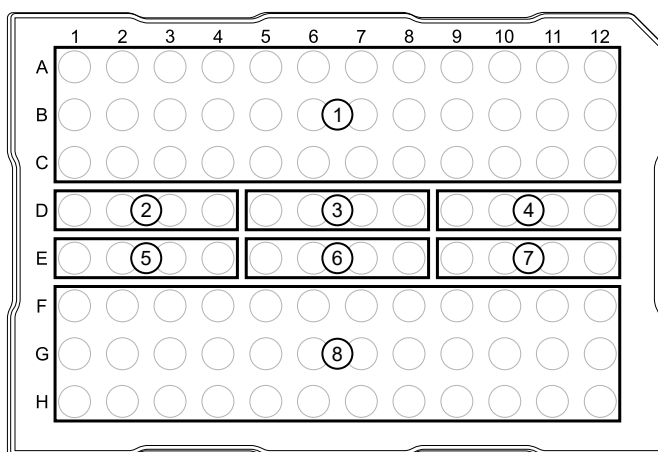

Figure 1 96-well RNase P plate

- | | |
|-----------------------------|----------------------|
| ① Unknown A (5,000) | ⑤ STD 5,000 copies |
| ② NTC (no template control) | ⑥ STD 10,000 copies |
| ③ STD 1,250 copies | ⑦ STD 20,000 copies |
| ④ STD 2,500 copies | ⑧ Unknown B (10,000) |

Performance specifications pass criteria

After the run, the software calculates average copy number values and standard deviation values. The instrument passes performance specifications if the following inequality is true and the instrument successfully distinguishes between unknown populations A and B with a statistical confidence level of 99.7%.

$$[(C_{tA}) - 3(\sigma_{C_{tA}})] > [(C_{tB}) + 3(\sigma_{C_{tB}})]$$

- C_{tA} = Average C_t of unknown population A
- $\sigma_{C_{tA}}$ = Standard deviation of unknown population A
- C_{tB} = Average C_t of unknown population B
- $\sigma_{C_{tB}}$ = Standard deviation of unknown population B

The software automatically adjusts the threshold and omits a defined number of wells from the unknown populations to meet the performance specifications. To view any omitted wells, open the EDS file for the verification in the desktop software.

Prepare an RNase P plate

Materials required for RNase P plate preparation

- RNase P instrument verification plate
- Centrifuge with plate adapter; buckets cleaned before use
- Powder-free gloves
- Safety glasses

Thaw, vortex, and centrifuge an RNase P plate

IMPORTANT! Expose the RNase P plate to room temperature for no more than 45 minutes, inclusive of thawing and preparation time.

After thawing, the RNase P plate cannot be refrozen.

1. Remove the RNase P plate from the freezer, then thaw the plate in its packaging.
 - Thaw the plate for approximately 5 minutes.
 - Use the plate within 30 minutes of thawing.
2. Confirm that the bench, vortex, and centrifuge are clean. Before use, wipe the vortex and centrifuge using a lint-free tissue.
3. While wearing powder-free gloves, remove the plate from its packaging.
4. Vortex the plate for 5 seconds, then centrifuge at 750–1,000 × g for 2 minutes.

- Confirm that the liquid in each well is at the bottom of the well and free of bubbles. If it is not, centrifuge the plate again.

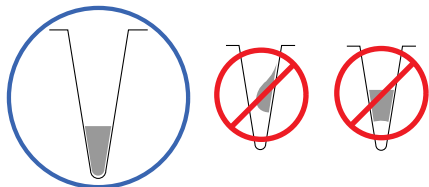

IMPORTANT! Keep the bottom of the plate clean. Fluids and other contaminants on the bottom of the plate can contaminate the sample block and cause an abnormally high background signal.

Perform RNase P verification

- In the home screen, touch **Settings** ▶ **Maintenance and Service** ▶ **RNase P Verification**.
- Load the plate into the instrument.
- Touch **Start**.
- When the run is complete and the screen displays **Verification Complete**, touch **View Results** to confirm the status of the run.

Calibration status	Action
Passed	Instrument is ready for use.
Failed	See “Troubleshoot verification failure” on page 69.

- In the **RNase P Verification Status** screen, touch one of the following options:
 - Accept Results** — Save the results to the instrument.
 - Reject Results** — Delete the RNase P verification results.
 - Export Results** — Export the calibration results to a USB.
- Unload the plate from the instrument.



CAUTION! PHYSICAL INJURY HAZARD. During instrument operation, the plate temperature can reach 100°C. Allow it to cool to room temperature before handling.

Troubleshoot verification failure

Observation	Possible cause	Recommended action
Verification failed	The plate was improperly prepared.	Ensure the following: <ul style="list-style-type: none"> The correct plate was used for the verification performed. The plate was properly thawed. The plate was properly centrifuged. The plate was properly sealed.
		Open the data file for the verification in the desktop software or Thermo Fisher™ Connect to view the flags and troubleshooting details for failed wells.
	The plate is damaged or contaminated.	Check for damage, improper plate seal, or contamination.
		Order a replacement plate. If the replacement plate fails, contact Support.
High fluorescence signal	The reaction volume is not correct.	Ensure that reaction volumes in the plate are correct and match the volume that is entered in the Method tab.
	Signals that exceed the limit of normal fluorescence may indicate fluorescent contaminants on the plate or the sample block.	Examine the bottom of the reaction plate. If there is contamination, prepare a new plate and run the experiment again.
		Identify the location of contamination on the plate or sample block. <ol style="list-style-type: none"> Obtain or prepare a background plate (see page 65). Follow the procedures that are described in “Identify contamination” on page 64.
Verification failed but plate is undamaged	The incorrect plate was used for verification.	Use the correct RNase P plate for verification.
	The plate was improperly prepared.	Repeat the verification with a new properly prepared plate. Note: The verification procedure is an experiment run, so each RNase P plate can only be used once.
		Open the data file for the verification in the desktop software or Thermo Fisher™ Connect to view the flags and troubleshooting details for failed wells.
		If the verification fails again, order a replacement plate. If the replacement plate fails, contact Support.

Calibrate custom dyes

Custom dyes overview

The instrument can run assays designed with custom dyes. Custom dyes include:

- Dyes that are not manufactured by Thermo Fisher Scientific.
- Dyes or formulations of dyes that are not system dyes for the instrument.
- For custom dye requirements, see “Custom dyes” on page 11.

Workflow: Custom dye calibration

For each custom dye, determine the optimal dye concentration. Use this concentration to prepare all subsequent dye calibration plates.

Use a dilution series to determine an optimal custom dye concentration

“Prepare a custom dye dilution plate” on page 71



“Run the dilution plate as an experiment” on page 71



“Determine the optimal dye concentration” on page 72



Calibrate the custom dye using the optimal concentration

Create a custom dye calibration plate



Add a custom dye to the instrument



“Perform a custom dye calibration” on page 73

Use a dilution series to determine an optimal custom dye concentration

Custom dye dilution guidelines

Prepare a dilution series for each custom dye.

- Target several dye concentrations within a range of 100–2,000 nM.
- Choose a 2- or 3-fold difference in dilution points.
- Dispense 10–20 μ L per well in a 96-well plate.
- Dilute the dye in buffer compatible with your master mix.
- (*Intercalating dyes only*) Add the appropriate amount of amplified PCR product to generate fluorescence.

Prepare a custom dye dilution plate

IMPORTANT! Wear powder-free gloves throughout the procedure.

1. Prepare a 2- or 3-fold dilution series of the custom dye.
2. Dispense aliquots of each dilution into the center of a reaction plate, then seal the plate.
 A full plate is not needed.
 See the following figure for suggested replicates.

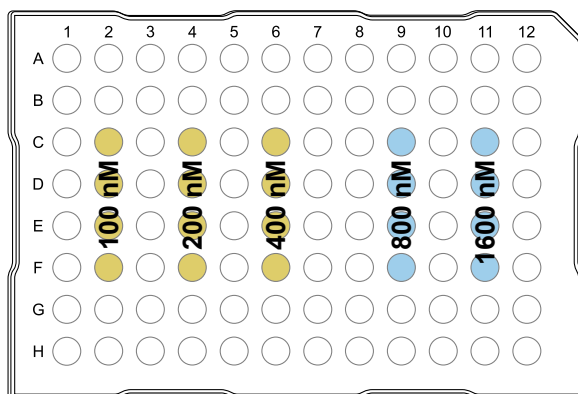

3. Vortex the plate for 5 seconds, then centrifuge at $750\text{--}1,000 \times g$ for 2 minutes.
4. Confirm that the liquid in each well is at the bottom of the well and free of bubbles. If it is not, centrifuge the plate again.

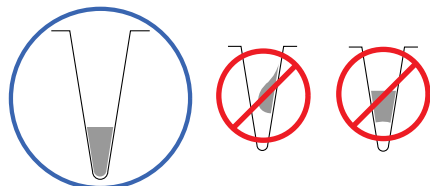

IMPORTANT! Keep the bottom of the plate clean. Fluids and other contaminants on the bottom of the plate can contaminate the sample block and cause an abnormally high background signal.

Run the dilution plate as an experiment

1. Load the plate into the instrument.
2. Set up a genotyping experiment on the instrument.
 - Load an experiment created in the desktop software.
 - a. In the home screen, touch **Load Experiment**.
 - b. Select the experiment location, then the experiment file.

- Create a new experiment on the instrument touchscreen.
 - a. In the home screen, touch **Open Template** ▶ **Genotyping** ▶ **Genotyping Post**.
 - b. (Optional) In the **Properties** tab, edit the experiment properties.
 - c. In the **Method** tab, set the hold temperature to 60°C with a 2 minute hold and enter the appropriate reaction volume.
 - d. In the **Plate** tab, enter the dilution series information for the appropriate wells.
- 3. Touch **Start Run**.
- 4. When the run is complete, download the results for analysis.
- 5. Unload the plate from the instrument.



CAUTION! PHYSICAL INJURY HAZARD. During instrument operation, the plate temperature can reach 100°C. Allow it to cool to room temperature before handling.

Determine the optimal dye concentration

Review the dye signal data and select the dilution to use for dye calibrate.

1. In the **Results** tab of the desktop software, select **Raw Data Plot**.
This plot displays the raw fluorescence signal of each optical filter, for individual wells.

Note: The **Raw Data Plot** cannot be viewed on the instrument touchscreen.

2. For each replicate population of dilutions, select the wells in the **Plate Layout** to view in the plot.
3. Examine the raw data to identify the wells yielding signals in the 800,000 to 3,200,000 range for the optical filter where the dye is brightest.
4. (Optional) Export the raw data, then calculate the average fluorescence value for each concentration.
5. Select the lowest (optimal) dye concentration that falls within the acceptable signal range.

Calibrate the custom dye

Create a custom dye calibration plate

IMPORTANT! Wear powder-free gloves while creating the dye plate.

Create a full plate of the custom dye diluted to the optimal concentration:

1. Dilute the custom dye to the optimal concentration in buffer.
Prepare an adequate volume, using a volume range of 10–20 µL/well for a 96-well plate.
2. Pipet the appropriate volume of the diluted custom dye to the plate wells.
3. Seal the plate.

- Vortex the plate for 5 seconds, then centrifuge at 750–1,000 × *g* for 2 minutes.
- Confirm that the liquid in each well is at the bottom of the well and free of bubbles. If it is not, centrifuge the plate again.

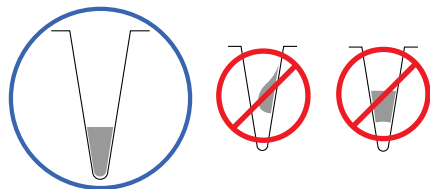

IMPORTANT! Keep the bottom of the plate clean. Fluids and other contaminants on the bottom of the plate can contaminate the sample block and cause an abnormally high background signal.

Add a custom dye to the instrument

- In the instrument home screen, touch **Settings** ▶ **Maintenance and Service** ▶ **Calibrations** ▶ **Custom** ▶ **Custom Dye**.
- Touch **Add Custom Dye**.
- Enter the dye information:

Field/option	Action
Custom Dye Name	Enter a name for the custom dye. IMPORTANT! <ul style="list-style-type: none"> Do not use a system dye name for a custom dye name. Dye names are spacing sensitive and cannot contain special characters.
Type	Select: <ul style="list-style-type: none"> Reporter—The dye works in conjunction with a quencher dye to report an increase of PCR product. Quencher—The dye suppresses the fluorescence of a reporter dye until amplification of PCR product. Both—The dye can be used as a reporter or quencher dye.

- Touch **Save**.

IMPORTANT! You must also add the custom dye to the desktop software dye library before creating, running, or analyzing experiments that use the custom dye. For detailed information, see the QuantStudio™ Design and Analysis Software help..

Perform a custom dye calibration

- Load the plate into the instrument.
- In the instrument home screen, touch **Settings** ▶ **Maintenance and Service** ▶ **Calibrations** ▶ **Custom** ▶ **Custom Dye**.

3. Touch the custom dye to calibrate.
4. Review the custom dye information, (*optional*) make changes, then touch **Update**.
5. Enter the calibration temperature.
6. (*Optional*) Touch **Reagents**, then enter reagent information.
7. Touch **Start**.
8. When the run is complete and the screen displays **Calibration Complete**, touch **View Results ▶ Details**.
9. Review the plot. Passing calibration results show uniform signals with peaks that are aligned with the dye wavelength.

Peak filter	Filter wavelength ^[1]	
	Excitation	Emission
x1-m1	470 ± 15 nm	520 ± 15 nm
x2-m2	520 ± 10 nm	558 ± 12 nm
x4-m4	580 ± 10 nm	623 ± 14 nm

^[1] The central wavelengths are the optimized wavelengths.

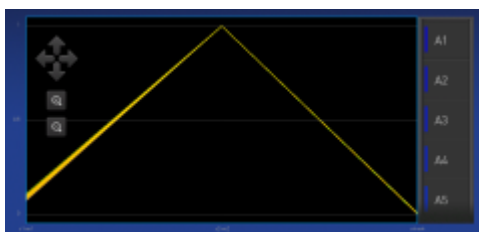

Figure 2 Example dye calibration plot

Note: The peaks for your dye may align with a different filter set.

10. Select an action depending on whether the custom dye calibration passed or failed.

Calibration status	Action
Passed	<ul style="list-style-type: none"> • Touch Accept Results or Reject Results. <p>Note: Accepting the results saves the calibration data to the instrument and overwrites existing data.</p> <ul style="list-style-type: none"> • (<i>Optional</i>) Touch Transfer EDS to transfer the calibration data to a USB.
Failed	<ul style="list-style-type: none"> • Perform the calibration again using a new custom dye plate. • See “Troubleshoot calibration failure” on page 64.

11. Unload the plate from the instrument.





CAUTION! PHYSICAL INJURY HAZARD. During instrument operation, the plate temperature can reach 100°C. Allow it to cool to room temperature before handling.

Calibrate for a custom melt curve experiment

Note: A custom melt calibration calibrates a custom dye and a melt calibration at the same time.

Before running the custom melt calibration complete the following tasks:

- Ensure that all calibrations are current (touch  **Settings** ▶ **Maintenance and Service** ▶ **Calibrations** ▶ **History and Reminders**).
 - Add a custom dye to the instrument (see “Add a custom dye to the instrument” on page 73).
1. In the home screen, touch  **Settings** ▶ **Maintenance and Service** ▶ **Calibrations** ▶ **Custom** ▶ **Custom Melt**.
 2. Touch **PCR + Melt** or **Melt only** as appropriate for the kit you are using.
 3. Load the plate into the instrument.
 4. Select or add a dye, then select a filter set appropriate for your dye's wavelength (see filter-wavelength table below).

Note: Refer to your reagent kit documentation for dye name and wavelength information.

Peak filter	Filter wavelength ^[1]	
	Excitation	Emission
x1-m1	470 ± 15 nm	520 ± 15 nm
x2-m2	520 ± 10 nm	558 ± 12 nm
x4-m4	580 ± 10 nm	623 ± 14 nm

^[1] The central wavelengths are the optimized wavelengths.

IMPORTANT! If the selected filter set does not match your reagent kit documentation, then the incorrect wavelength may be collected during a run.

5. (Optional) Touch **Reagents**, then enter reagent information.
6. Touch **Start**.
7. When the run is complete and the screen displays **Calibration Complete**, touch **View Results** ▶ **Details**.

8. Review the plot. Passing calibration results show uniform signals with peaks that are aligned with the dye wavelength.

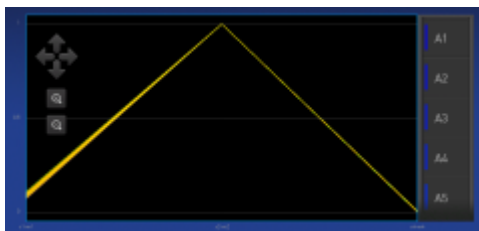

Figure 3 Example dye calibration plot

Note: The peaks for your dye may align with a different filter set.

9. Select an action depending on whether the custom dye calibration passed or failed.

Calibration status	Action
Passed	<ul style="list-style-type: none"> • Touch Accept Results or Reject Results. <p>Note: Accepting the results saves the calibration data to the instrument and overwrites existing data.</p> <ul style="list-style-type: none"> • (Optional) Touch Transfer EDS to transfer the calibration data to a USB.
Failed	<ul style="list-style-type: none"> • Perform the calibration again using a new custom dye plate. • See “Troubleshoot calibration failure” on page 64.

10. Unload the plate from the instrument.

Note:

- You must also add the custom dye to the desktop software dye library before creating, running or analyzing experiments that use custom dyes.
- To perform a custom melt experiment, you can either create a Standard Curve or a Custom experiment with melt, then specify the data points per degree in the method.



Maintain the instrument

- Backup or restore the instrument 77
- Decontaminate the sample block 78
- Replace the instrument fuses 81
- Prepare the instrument to store, move, or ship 82

IMPORTANT! This chapter contains user maintenance procedures for the instrument. Procedures other than those described in this document must be performed by a qualified Thermo Fisher Scientific service representative.

Backup or restore the instrument

In the home screen, touch  **Settings** ▶ **Maintenance and Service** ▶ **Backup/Restore**.

To	Action
Backup	<ol style="list-style-type: none">1. Touch Backup Instrument.2. Select a location to store the backup settings for your instrument.3. If backing up to a USB drive, insert a USB drive into the front-panel USB port.4. Enter a backup file name, then touch Done.5. Select the elements to backup, or leave them all selected.6. Touch Backup.
Restore (Administrator only)	<ol style="list-style-type: none">1. Touch Restore a Backup.2. Select the storage location of the backup settings.3. If restoring from a USB drive, insert a USB drive into the front-panel USB port.4. Select the backup file, then touch Restore.

Decontaminate the sample block

Perform this procedure to eliminate fluorescent contaminants from the instrument sample block. Contamination is generally evident in failed background calibrations where one or more wells consistently exhibit abnormally high signals.



CAUTION! PHYSICAL INJURY HAZARD. Do not remove the instrument cover. There are no components inside the instrument that you can safely service yourself. If you suspect a problem, contact Support.



CAUTION! PHYSICAL INJURY HAZARD. During instrument operation, the sample block temperature can reach 100°C. Allow it to cool to room temperature before handling.



CAUTION! Before using a cleaning or decontamination method other than those recommended by Thermo Fisher Scientific, confirm with Thermo Fisher Scientific that the proposed method will not damage the equipment.

Materials required

- Safety glasses
- Powder-free gloves
- Tissue, lint-free
- Cotton or nylon swabs and lint-free cloths
- Pipette (100- μ L) with pipette tips
- Deionized water
- Ethanol, 95% solution
- Na-hypochlorite, (0.1% v/v) solution

Clean the sample block



CAUTION! PHYSICAL INJURY HAZARD. During instrument operation, the sample block temperature can reach 100°C. Allow it to cool to room temperature before handling.

IMPORTANT!

- Wear powder-free gloves when you perform this procedure.
- Always use deionized water to rinse wells after cleaning with bleach or ethanol solution.

-
1. Identify the contaminated wells of the sample block (see “Identify contamination” on page 64).
 2. Prepare the instrument and access the sample block.
 - a. Power off and unplug the instrument, then allow it to cool for 15 minutes.

- b. Pull the instrument drawer forward to expose the sample block.
3. Rinse the contaminated wells with deionized water (see “Detailed procedures for cleaning the sample block” on page 80).

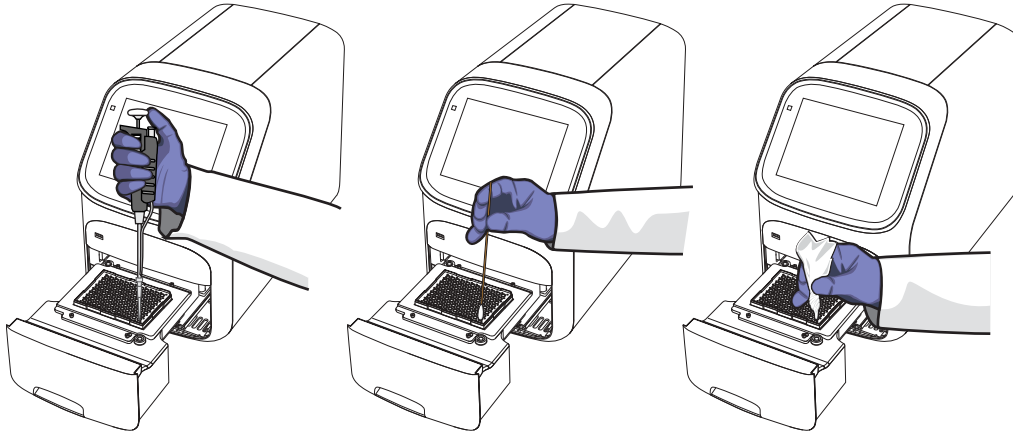

- a. Push the instrument drawer back in to the instrument.
 - b. Plug in, then power on the instrument.
 - c. Perform a background calibration to confirm that you have eliminated the contamination.
4. Close the drawer and test the sample block for contamination.
5. If the contamination remains, clean the contaminated wells using a 95% ethanol solution.
 - a. Repeat step 2 – step 3.
 - b. Clean the contaminated wells using a 95% ethanol solution (see “Detailed procedures for cleaning the sample block” on page 80).
 - c. Repeat step 3 – step 4 to rinse the sample block with deionized water and to confirm that you have eliminated the contamination.

IMPORTANT! Always use deionized water to rinse wells after cleaning with bleach or ethanol solution.

- a. Repeat step 2 – step 3.
 - b. Clean the contaminated wells using a Na-hypochlorite (0.1% v/v) solution (see “Detailed procedures for cleaning the sample block” on page 80).
6. If the contamination remains, clean the contaminated wells using a Na-hypochlorite (0.1% v/v) solution.
 - a. Repeat step 2 – step 3.
 - b. Clean the contaminated wells using a Na-hypochlorite (0.1% v/v) solution (see “Detailed procedures for cleaning the sample block” on page 80).

- c. Repeat step 3 – step 4 to rinse the sample block with deionized water and to confirm that you have eliminated the contamination.

IMPORTANT! Always use deionized water to rinse wells after cleaning with bleach or ethanol solution.

7. If the contamination continues to remain, contact Support.

Detailed procedures for cleaning the sample block

IMPORTANT! Use these cleaning procedures *only* in conjunction with the complete decontamination procedure (see “Decontaminate the sample block” on page 78).

- Rinse the sample block with deionized water.
 - a. Pipet a small volume of deionized water into each contaminated well.
 - b. In each well, pipet the water up and down several times to rinse the well.
 - c. Pipet the water to a waste beaker.
 - d. Use a cotton swab to scrub inside of each contaminated well.
 - e. Use a lint-free cloth to absorb the excess deionized water.
- Clean the sample block with 95% ethanol.
 - a. Pipet a small volume of 95% ethanol solution into each contaminated well.
 - b. In each well, pipet the solution up and down several times to rinse the well.
 - c. Pipet the ethanol solution to a waste beaker.

IMPORTANT! Always use deionized water to rinse wells after cleaning with bleach or ethanol solution.

- Clean the sample block with Na-hypochlorite (0.1% v/v) solution.
 - a. Pipet a small volume of Na-hypochlorite (0.1% v/v) solution into each contaminated well.
 - b. In each well, pipet the solution up and down several times to rinse the well.
 - c. Pipet the bleach solution to a waste beaker.

IMPORTANT! Always use deionized water to rinse wells after cleaning with bleach or ethanol solution.

Replace the instrument fuses



CAUTION! FIRE HAZARD. For continued protection against the risk of fire, replace fuses only with listed and certified fuses of the same type and rating as those currently in the instrument.

Materials required

- Fuses (2) – 10A, Time-Lag T, 250VAC, 5 × 20mm
- Safety glasses
- Powder-free gloves
- Screwdriver, flathead

Replace the fuses

1. Power off and unplug the instrument, then allow it to cool for 15 minutes.
2. Using a flat-head screwdriver, unscrew and remove the fuse holder.

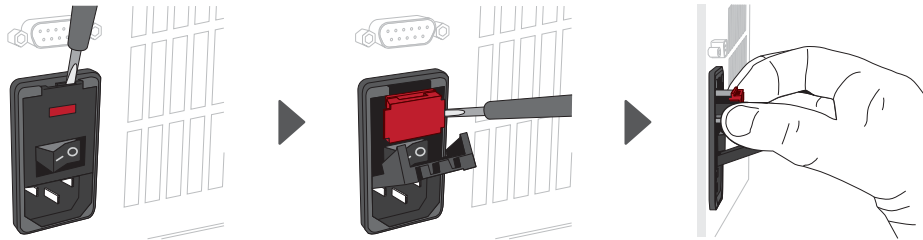

3. Remove each fuse from its fuse holder and inspect it for damage. Carbon typically coats the inside of failed fuses.

Good	Failed

4. Replace each failed fuse.

Note: The voltage and amperage ratings are on the fuse holder.

5. Install the fuse holder back into the instrument.
6. Plug in, then power on the instrument.
The installation is successful if the instrument powers on.

Note: Fuse failure can result from fluctuations in the supplied power to the system. To prevent further failures, consider installing an electrical protective device, such as a UPS or a surge protector. If issues with the fuse persist, contact Support.

Prepare the instrument to store, move, or ship

1. In the home screen, touch  **Settings** ▶ **Maintenance and Service** ▶ **Ship Prep Mode** ▶ **Next**.
2. Open the instrument drawer.
3. Load the packing plate or an empty plate, then close the drawer.
4. Touch **Lock Block**.
5. Power off the instrument using the power switch on the back of the instrument.

The instrument is now ready to store, move, or ship.

Move the instrument



CAUTION! PHYSICAL INJURY HAZARD. Do not attempt to lift the instrument or any other heavy objects unless you have received related training. Incorrect lifting can cause painful and sometimes permanent back injury. Use proper lifting techniques when lifting or moving the instrument. At least two people are required to lift it.

IMPORTANT! Moving your instrument can create subtle changes in the alignment of the instrument optics. Recalibrate the instrument if necessary.

- Ensure that the surface on which you place the instrument can support at least 35 kg (77 lbs).
- Ensure that the path to transport the instrument is clear of obstructions.
- At least two people are needed to lift and carry the instrument.
- Keep your spine in a good neutral position.
- Bend at the knees and lift with your legs.
- Do not lift an object and twist your torso at the same time.
- Coordinate your intentions with your assistant before lifting and carrying.

IMPORTANT! After moving the instrument, perform an RNase P instrument verification run. If the run fails, perform ROI/ uniformity, background, and dye calibrations.

Return the instrument for service

The service process requires 2 to 3 weeks.

Before returning the instrument for service, perform the following tasks.

1. Back up the instrument (see “Backup or restore the instrument” on page 77).
2. In the home screen, touch **⊗ Settings ▶ Instrument Settings ▶ Reset Factory defaults**.
3. Set the instrument to **Ship Prep Mode** (see “Prepare the instrument to store, move, or ship” on page 82).

To return the instrument for service, perform the following tasks.

1. Contact your local customer care center or technical support group to obtain a copy of the Certificate of Instrument Decontamination, a service notification, a service call number, and packaging materials (if required).

2. Follow the instructions in the form to decontaminate the instrument.

IMPORTANT! The instrument must be decontaminated before packing it for shipping.

3. Complete and sign a copy of the Certificate of Instrument Decontamination.
4. Fax the Certificate of Instrument Decontamination to the customer care center.
5. Pack the instrument in the provided packaging and follow the instructions in the table below.

Prepare	Include	Exclude
<ol style="list-style-type: none"> 1. Transfer any data files from the instrument. 2. Load an empty plate in the sample block. 3. Use the touchscreen to place the instrument in ship mode. <p>Note: The empty plate and ship mode protects the internal components of the instrument during transport.</p>	<ul style="list-style-type: none"> • Instrument • Completed and signed Certificate of Instrument Decontamination <p>Note: The instrument will not be accepted for service without a hard copy of the Certificate of Instrument Decontamination.</p>	<p>Any accessories, including:</p> <ul style="list-style-type: none"> • Power cord • Ethernet cable • USB drive • Wireless adapter <p>Note: If included with the instrument, these items will be disposed of during service and not returned.</p>

6. Attach the postage provided with the Certificate of Instrument Decontamination to the box, then ship the instrument to the designated facility.



Install and connect the instrument to a network

- Workflow: Install and connect to a network 84
- Before you begin 85
- Instrument and computer connections 85
- Unpack and install the instrument 86
- Power on and follow the startup wizard 87
- Connect the computer to the instrument directly or to a LAN 87
- Networking 88

Workflow: Install and connect to a network

Perform all steps in “Before you begin” on page 85



“Unpack and install the instrument” on page 86



“Power on and follow the startup wizard” on page 87



“Perform instrument verification using RNase P plates” on page 65



“Connect the computer to the instrument directly or to a LAN” on page 87

Before you begin

This section provides instructions for customer installation of the computer and the instrument. For installation by a field service engineer (FSE), contact Support to order a service call.

Before starting the installation, complete the following tasks:

- Determine the configuration for your instrument and obtain the network information you need (see “Networking” on page 88).
- Review site requirements (see *QuantStudio™ 1 Real-Time PCR System Site Preparation Guide* (Pub. No. MAN0017854).
- Review instrument and computer connections (see “Instrument and computer connections” on page 85).

Instrument and computer connections

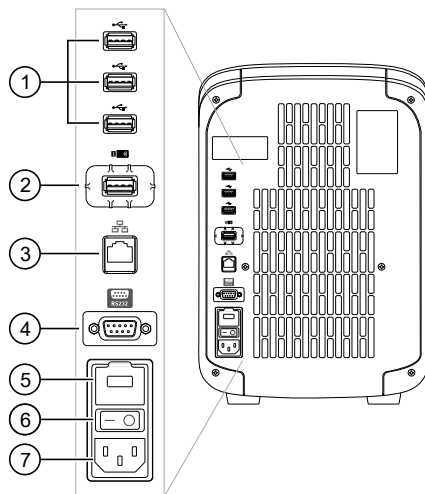

Figure 4 Instrument back panel

- | | |
|---|-----------------------------------|
| ① USB ports | ④ RS232 Port—For service use only |
| ② WiFi USB port—Connect USB wireless adapter for wireless network access (ordered separately) | ⑤ Fuse Cover |
| ③ Ethernet Port—RJ45 port for 100/1,000 Mbps Ethernet communication with the instrument | ⑥ Power Switch |
| | ⑦ Power Port—100 to 240 VAC |

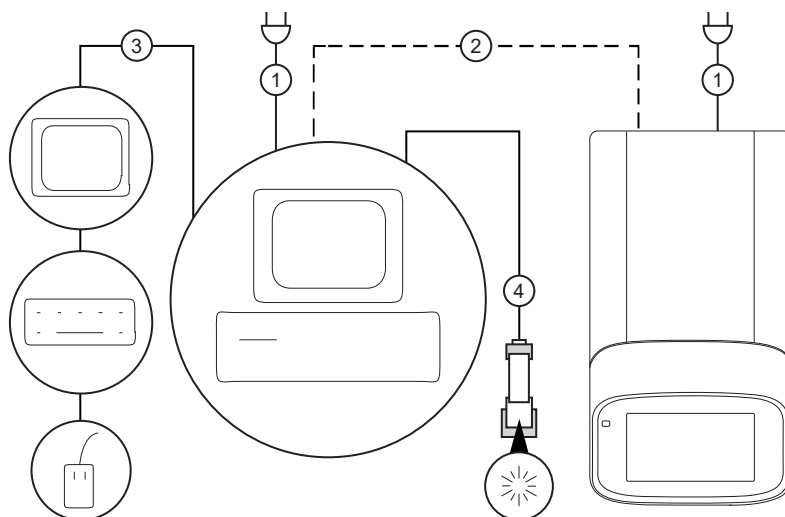

Figure 5 Instrument-to-computer connections (barcode scanner connected to the computer) Minitower configuration

- ① Detachable power supply cord compatible with local power supply receptacle.
- ② Connection between the computer and the instrument.
- ③ Connection between the computer and the monitor, keyboard, and mouse.
- ④ Connection between the computer and the (*optional*) handheld barcode scanner.

Unpack and install the instrument

1. Prepare the installation site as described in the *QuantStudio™ 1 Real-Time PCR System Site Preparation Guide* (Pub. No. MAN0017854).
2. Follow the pre-printed instructions on the instrument box to unpack the instrument, accessories, and reference documentation. Save the packing material for future use or recycle it.

The instrument box contains:

- Reference documentation: Welcome note, unpacking and set up instructions card, system documentation insert
- One instrument
- Accessories: power cable, Ethernet cable, USB drive, reaction tube retainer
- Shipping plate

Note: Save the shipping plate but do not use it to operate the instrument.

If you ordered the wireless adapter, it is provided separately.

3. Place the instrument on the bench.
4. Plug the power cable into the power port on the back panel of the instrument, then plug the cable into an electrical receptacle.

5. Connect your instrument as required by your network configuration (see “Supported options for instrument and computer connections” on page 17 and “Instrument and computer connections” on page 85).
 - Connect an Ethernet cable to the Ethernet port on the back panel of the instrument, then connect the cable to a computer or a networking port.
or
 - Connect wirelessly via the wireless adapter.

Note: Do not connect the High Power USB WiFi Module (Cat. No. A26774) to the instrument if it is connected to a network by an Ethernet cable. Configuring the instrument for both wired and wireless connection can interfere with instrument operation.

Power on and follow the startup wizard

1. Power on the instrument.
2. Follow the startup wizard through the following tasks:
 - Select the language for the instrument.
 - Accept the license agreement.
 - Select a **Wired** or **Wireless** networking option, as needed for your configuration (see “Supported options for instrument and computer connections” on page 17).
 - Configure the instrument date and time.
 - Create an administrator instrument profile.

Note: You can perform any of the steps above at a later time if you do not have the information needed to complete the startup screens. See Chapter 3, “Configure the instrument and manage instrument profiles”.

IMPORTANT! Before using the instrument for the first time, we recommend that you perform instrument verification using RNase P plates (see “Perform instrument verification using RNase P plates” on page 65).

Connect the computer to the instrument directly or to a LAN

This section describes the direct wired connection of the computer to the instrument or to a LAN.

1. Connect an Ethernet cable from the instrument or a LAN to the computer.
2. Power on the computer, then log in using a Windows™ Administrator account.
3. Open the **Control Panel**, then open the **Network and Sharing Center**.
4. In the left pane of the **Network and Sharing Center** window, click **Change Adapter Settings**.



5. Right-click on **Broadband Connection**, then select **Properties**.
6. In the **Networking** tab, select **Internet Protocol Version 4 (TCP/IPv4)**.
7. Click **Properties**.
8. In the **Internet Protocol Version 4 (TCP/IPv4) Properties** dialog box, select one of the following options.
 - **Obtain an IP address automatically**
 - **Use the following IP address**
9. If **Use the following IP address** was selected, enter the *IP address*.
10. Close all dialog boxes by clicking **OK**, then re-start the computer.

Networking

IMPORTANT! This section provides general networking information. It *does not* provide adequate detail to integrate the instrument into all possible network architectures. Because a network may contain advanced features (such as a firewall or network domains), we recommend that you consult a network administrator before connecting the instrument to your laboratory network.

Supported options for instrument and computer connections

We support the following direct, networked (LAN–local area network), or Thermo Fisher™ Connect configurations. Configurations other than those listed are not recommended. Select a configuration that meets the needs of your laboratory's instrument, software, and workflow requirements.

IMPORTANT! Do *not* connect *both* an Ethernet cable and the Wi-Fi module (Cat. No. A26774) to the instrument. Configuring the instrument for both wired and wireless connection can interfere with instrument operation.

Note: For detailed information about networking your instrument, see the *QuantStudio™ 1 Real-Time PCR System IT Checklist* (Pub. No. MAN0018164).

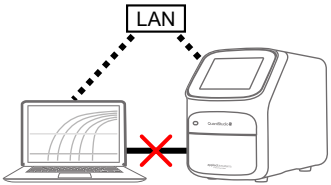
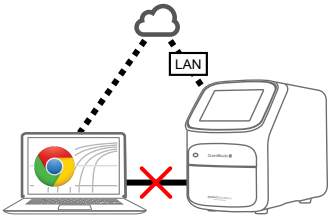
Direct configuration option	
<ul style="list-style-type: none"> A computer provided by Thermo Fisher Scientific with the QuantStudio™ Design and Analysis Desktop Software 	
<ul style="list-style-type: none"> Computer-to-instrument connection: <ul style="list-style-type: none"> Direct, wired connection between the computer and the instrument using an Ethernet cable <p>IMPORTANT! A direct instrument-to-computer connection <i>cannot</i> be combined with the LAN or the Thermo Fisher™ Connect configurations.</p>	
Networked configuration option	
<ul style="list-style-type: none"> A computer provided by Thermo Fisher Scientific with the QuantStudio™ Design and Analysis Desktop Software The computer and instrument must have the same subnet mask within the same network. 	
<ul style="list-style-type: none"> Computer-to-LAN connection (<i>select an option</i>): <ul style="list-style-type: none"> Wired connection to the network using an Ethernet cable –or– Wireless connection to the network 	
<ul style="list-style-type: none"> Instrument-to-LAN connection (<i>select an option</i>): <ul style="list-style-type: none"> Wired connection to the network using an Ethernet cable –or– Wireless connection to the network using the instrument Wi-Fi module 	
Thermo Fisher™ Connect configuration option	
<ul style="list-style-type: none"> Internet access and a computer with the Chrome™ web browser to access Thermo Fisher™ Connect 	
<ul style="list-style-type: none"> Computer-to-Thermo Fisher™ Connect connection (<i>select an option</i>): <ul style="list-style-type: none"> Wired connection to the internet using an Ethernet cable –or– Wireless connection to the internet 	
<ul style="list-style-type: none"> Instrument-to-Thermo Fisher™ Connect connection (<i>select an option</i>): <ul style="list-style-type: none"> Wired connection to the network using an Ethernet cable –or– Wireless connection to the network using the instrument Wi-Fi module 	

Control and monitor networked instruments

When the instrument is connected to a network:

- Computers on the network that are running the desktop software can control the instrument. Networked instruments can be controlled by only one computer at a time.
- Instruments linked to Thermo Fisher™ Connect cannot be controlled remotely. However, you can perform the following functions:
 - Remotely access Thermo Fisher™ Connect to create (and analyze) experiments.
 - From the instrument, download the experiments and start a run.
 - Monitor a run from Thermo Fisher™ Connect in real time.

Ethernet port overview

The Ethernet port of the instrument supports:

- Static IP network service with subnet mask, primary and secondary data network service (DNS), and default gateway settings, or dynamic host configuration protocol (DHCP) network service.
- mDNS/DNS for local domains.

Note: Because mDNS is limited to direct network connections, an instrument configured for mDNS may not be visible to other nodes that are separated by a router, hub, or another network device.

- IPv4 linklocal (IPv4LL) in the RFC (also known as Automatic Private IP Addressing [APIPA] or Internet Protocol Automatic Configuration [IPAC]).

Note: When an instrument is set for DHCP, APIPA is automatically enabled, and the instrument provides an IP address when no address is supplied by the DHCP server.

Firewall ports that must be open

Ports	Condition
80/443	Standard ports for instrument-to-Thermo Fisher™ Connect and computer-to-Thermo Fisher™ Connect connections
mDNS, 7443	Instrument-to-computer connection
mDNS, 5353	Instrument discovery

Networking guidelines and best practices

- Consult a network administrator before connecting the instrument to a network.
- To enable the full functionality of the software, the computer requires a network connection.
- Open the firewall port for the instruments to be discovered. See “Firewall ports that must be open” on page 90.
- Observe the restrictions to mDNS and Autodiscovery.
The instrument supports mDNS but only when the instrument and computer share a direct network connection and are within the same subnet. Network computers that are separated from the instrument by a router, hub, or another network device may not be able to access the instrument by its host name.
- Confirm the uniqueness of the instrument name.
 - The instrument name must be unique within the subnet. The desktop software can automatically discover instruments on the link-local network.
 - The instrument does not test the uniqueness of the instrument name within the subnet when it is set.



Troubleshooting

Observation	Possible cause	Recommended action
Inconsistent communication between instrument and computer or instrument and Thermo Fisher™ Connect	The instrument is configured for <i>both</i> wired and wireless network connection.	Ensure only one connectivity option is plugged into the instrument (either an Ethernet cable <i>or</i> a wireless adapter, but not both). Configure for wired <i>or</i> wireless network connection.
	Weak or unstable internet connection, especially if configured for wireless.	Change the configuration to a wired connection.
		Use a wireless network with a stronger or more consistent signal.
The connection between the instrument and the computer is not recognized	The connection is not fully established.	Power the instrument off, then power it on again.
	If using a networked configuration, the instrument and computer are not on the same subnet mask.	Contact your information technologies department to have them ensure that the instrument and computer are on the same subnet mask.
	If using a networked configuration, the instrument or computer has an invalid IP address.	Contact your information technologies department to have them ensure that the IP addresses are valid.
Insufficient disk space message	Insufficient disk space to save a run.	<ol style="list-style-type: none"> In the home screen, touch  Settings ▶ Run History ▶ Manage. Delete or transfer experiments from the instrument.
The touchscreen is black	The instrument is in sleep mode.	Touch anywhere on the instrument touchscreen.
	The instrument is not powered on.	If you touch the instrument touchscreen and it remains black, check if the instrument is powered on. The power switch is located on the rear panel of the instrument.
		If the instrument does not power on, check that the instrument is properly plugged in.
		If the instrument does not power on and the instrument is properly plugged in, contact Support.
Forgot PIN for instrument profile	Non-administrator forgot instrument profile PIN.	See “Manage all instrument profiles (Administrator only)” on page 40.

Observation	Possible cause	Recommended action
Forgot PIN for instrument profile <i>(continued)</i>	Administrator forgot instrument profile PIN.	Have another administrator reset the PIN for the forgotten-PIN profile (see “Manage all instrument profiles (Administrator only)” on page 40).
		If there is not another administrator profile on the instrument, you must restore factory defaults (see “Restore factory defaults” on page 36).
High fluorescence signal	The reaction volume is not correct.	Ensure that reaction volumes in the plate are correct and match the volume that is entered in the Method tab.
	Signals that exceed the limit of normal fluorescence may indicate fluorescent contaminants on the plate or the sample block.	Examine the bottom of the reaction plate. If there is contamination, prepare a new plate and run the experiment again.
		Identify the location of contamination on the plate or sample block. <ol style="list-style-type: none">1. Obtain or prepare a background plate (see page 65).2. Follow the procedures that are described in “Identify contamination” on page 64.



Instrument specification and layout

- Configured system dimensions 95
- Electrical requirements 96
- Environmental requirements 97
- Network requirements 97



Configured system dimensions

Allow space for the configured instrument. A typical setup with a co-located minitower computer is shown below.

Note: Dimensions are rounded to the nearest whole or half unit.

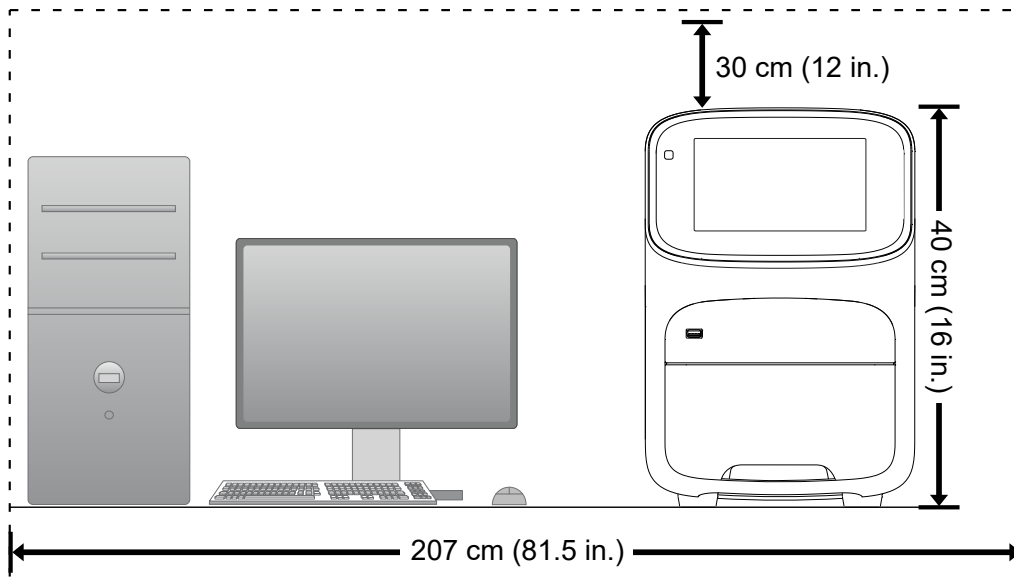
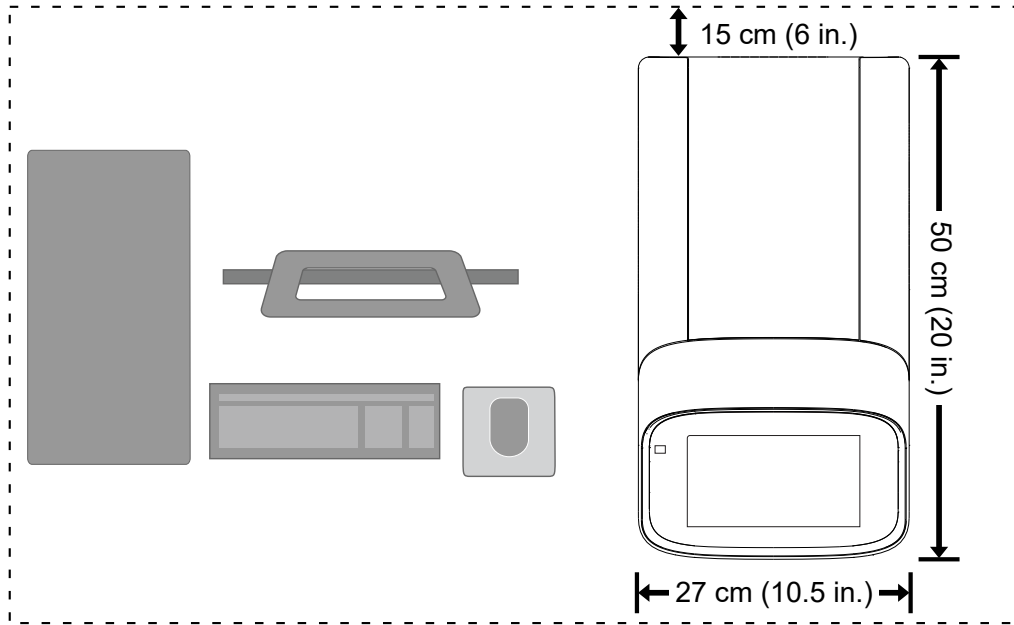



Instrument clearances

During instrument installation and maintenance, it is necessary to access the back of the instrument. If the back of the instrument faces a wall, ensure that there is sufficient clearance on the bench to rotate the instrument for access.

IMPORTANT! For safety, the power outlet for the instrument must be accessible.

Component	Top	Front	Sides	Back
Instrument	30 cm (12 in.)	30 cm (12 in.)	15 cm (6 in.)	15 cm (6 in.)
Computer ^[1]	—	15 cm (6 in.)	—	15 cm (6 in.)

^[1] Co-locating the computer with the instrument is optional.

Electrical requirements



WARNING! For safety, the power outlet used for powering the instrument must be accessible at all times. See “Instrument clearances” on page 96 for information about the space needed between the wall and the instrument. In case of emergency, you must be able to immediately disconnect the main power supply to all the equipment. Allow adequate space between the wall and the equipment so that the power cords can be disconnected in case of emergency.

- Electric receptacle with grounding capability
- Maximum power dissipation: ~960 W (not including computer and monitor)
- Mains AC line voltage tolerances must be up to ± 10 percent of nominal voltage

Device	Rated voltage	Circuit required	Rated frequency	Rated power
Instrument	100–240 $\pm 10\%$ VAC ^[1]	10 A	50/60 Hz	750 W
Computer (laptop)	100–240 $\pm 10\%$ VAC	10 A	50/60 Hz	90 VA
Computer (desktop)	100–240 $\pm 10\%$ VAC	10 A	50/60 Hz	125 VA
Monitor				65 VA

^[1] If the supplied power fluctuates beyond the rated voltage, a power line regulator may be required. High or low voltages can adversely affect the electronic components of the instrument.



Environmental requirements

Table 2 Environmental requirements

Condition	Acceptable range
Installation site	Indoor use only
Electromagnetic interference	Do not use this device in close proximity to sources of strong electromagnetic radiation (for example, unshielded intentional RF sources). Strong electromagnetic radiation may interfere with the proper operation of the device.
Altitude	Between sea level and 2000 m (6500 ft) above sea level
Operating conditions	<ul style="list-style-type: none"> Humidity: 15–80% relative humidity (noncondensing) Temperature: 15°C to 30°C (59°F to 86°F) <p>Note: For optimal performance, avoid rapid or extreme fluctuations in room temperature.</p>
Storage and transport conditions	<ul style="list-style-type: none"> Humidity: 20–80% relative humidity (noncondensing) Temperature: –30°C to 60°C (–22°F to 140°F)
Thermal output	During operation, the net thermal output, based on the actual current draw of the instrument, is expected to be approximately 960 W (3275 Btu/h).
Vibration	Ensure that the instrument is not adjacent to strong vibration sources, such as a centrifuge, pump, or compressor. Excessive vibration will affect instrument performance.
Pollution degree	<p>The instrument has a Pollution Degree rating of II. The instrument may only be installed in an environment that has nonconductive pollutants such as dust particles or wood chips. Typical environments with a Pollution Degree II rating are laboratories and sales and commercial areas.</p> <p>The noise output of the instrument is ≤ 60 dB when running.</p>
Other conditions	<p>Ensure the instrument is located away from any vents that could expel particulate material onto the instrument components.</p> <p>Avoid placing the instrument and computer adjacent to heaters, cooling ducts, or in direct sunlight.</p>

Network requirements

The instrument:

- Is factory-configured for IPv4 TCP/IP communication and includes an Ethernet adapter (100/1,000 Mbps) with an RJ45-type connector for integrating the device into a local area network (LAN).
- Can alternatively be configured for wireless networking (High Power USB WiFi Module required, sold separately as an optional accessory).

The instrument can be configured for *either* wired or wireless networking, not both.



If a Thermo Fisher Scientific service representative is to install the instrument:

- If the instrument will be connected to a LAN, an active, tested network jack must be in place before the scheduled installation date.
- A representative from your information technologies department must be available during the installation to help connect the instrument to your network.

Required materials to network the instrument:

- Wired—Ethernet cable of sufficient length with RJ45 connectors
 - CAT5 cable for a 100 Mbps network connection
 - CAT5e or CAT6 cable for a 1,000 Mbps network connection
- or–
- Wireless—High Power USB WiFi Module (Cat. No. A26774, sold separately)



Parts and materials

- Kits, consumables, accessories, and reagents 99
- Consumables (96-well, 0.2-mL format) 99
- Accessories 100
- General-use materials and consumables 100

Kits, consumables, accessories, and reagents

Unless otherwise indicated, all materials are available through thermofisher.com.

Store all calibration and RNase P plates at -20°C . All other items can be stored at $15\text{--}30^{\circ}\text{C}$. Use all materials by the expiration date on the packaging.

Catalog numbers that appear as links open the web pages for those products.

Consumables (96-well, 0.2-mL format)

Consumable	Amount	Cat. No.
MicroAmp™ Optical 8-Cap Strips	300 strips	4323032
MicroAmp™ Optical 8-Tube Strip, 0.2 mL	125 strips	4316567
MicroAmp™ Optical Tube without Cap, 0.2 mL	2,000 tubes	N8010933
MicroAmp™ Optical 96-Well Reaction Plate with Barcode	20 plates	4306737
	500 plates	4326659
MicroAmp™ EnduraPlate™ Optical 96-Well Clear GPLE Reaction Plates with Barcode	20 plates	4483348
	500 plates	4483351

Instrument verification or calibration plate	Cat. No.
TaqMan™ RNase P Instrument Verification Plate, 96-Well 0.2-mL	4432382
Region of Interest (ROI) and Background Plates, 96-Well 0.2-mL (2 plates)	4432364
QuantStudio™ 3/5 Spectral Calibration Plate 1 (FAM™, VIC™, ROX™, and SYBR™ dyes), 96-Well 0.2-mL ^[1]	A26331
QuantStudio™ 3/5 Spectral Calibration Plate 2, 96-Well 0.2-mL (ABY™, JUN™, and MUSTANG PURPLE™ dyes) ^[1]	A26332

^[1] Compatible with the QuantStudio™ 1 Real-Time PCR Instrument.

Accessories

Item	Amount	Cat. No.
MicroAmp™ 96-Well Tray/Retainer Set	10 trays	4381850
MicroAmp™ Multi Removal Tool	1 tool	4313950
MicroAmp™ Cap Installing Tool (handle style)	1 tool	4330015
MicroAmp™ Optical Adhesive Film	25 films	4360954
	100 films	4311971
MicroAmp™ Adhesive Film Applicator	5 applicators	4333183
RT-PCR Grade Water	10 × 1.5 mL tubes	AM9935
Handheld Barcode Scanner	1 scanner	4488442
High Power USB WiFi Module	1 module	A26774

General-use materials and consumables

The following general-use materials and consumables are required to calibrate, maintain, and operate the instrument.

Unless otherwise indicated, all materials are available through thermofisher.com. "MLS" indicates that the material is available from fisherscientific.com or another major laboratory supplier.

Material/Consumable	Source
Centrifuge with 96-well plate buckets	MLS
Cotton or nylon swabs and lint-free cloths	MLS
Ethanol, 95% solution	MLS
Optical clear adhesive film for PCR	MLS

(continued)

Material/Consumable	Source
Na-hypochlorite, 0.1% v/v solution	
Pipettors, 100- μ L and 200- μ L (with pipette tips)	MLS
Powder-free gloves	MLS
Safety glasses	MLS
Screwdriver, flathead	MLS
Tissue, lint-free	MLS
Deionized water	MLS



Safety

■ Symbols on this instrument	102
■ Safety alerts on this instrument	104
■ Safety information for instruments not manufactured by Thermo Fisher Scientific	106
■ Instrument safety	106
■ Safety and electromagnetic compatibility (EMC) standards	107
■ Chemical safety	110
■ Biological hazard safety	111



WARNING! GENERAL SAFETY. Using this product in a manner not specified in the user documentation may result in personal injury or damage to the instrument or device. Ensure that anyone using this product has received instructions in general safety practices for laboratories and the safety information provided in this document.

- Before using an instrument or device, read and understand the safety information provided in the user documentation provided by the manufacturer of the instrument or device.
- Before handling chemicals, read and understand all applicable Safety Data Sheets (SDSs) and use appropriate personal protective equipment (gloves, gowns, eye protection, and so on). To obtain SDSs, see the “Documentation and Support” section in this document.







Symbols on this instrument

Symbols may be found on the instrument to warn against potential hazards or convey important safety information. In this document, the hazard symbol is used along with one of the following user attention words:

- **CAUTION!** – Indicates a potentially hazardous situation that, if not avoided, may result in minor or moderate injury. It may also be used to alert against unsafe practices.
- **WARNING!** – Indicates a potentially hazardous situation that, if not avoided, could result in death or serious injury.
- **DANGER!** – Indicates an imminently hazardous situation that, if not avoided, will result in death or serious injury.

Symbol	Description
	Caution, risk of danger Consult the manual for further safety information.

(continued)

Symbol	Description
	Moving parts
	Caution, hot surface
	On
	Off
	Protective conductor terminal (main ground)
	Do not dispose of this product in unsorted municipal waste  CAUTION! To minimize negative environmental impact from disposal of electronic waste, do not dispose of electronic waste in unsorted municipal waste. Follow local municipal waste ordinances for proper disposal provision and contact customer service for information about responsible disposal options.

Conformity symbols



Conformity mark	Description
	Indicates conformity with safety requirements for Canada and U.S.A.
	Indicates conformity with European Union requirements for safety and electromagnetic compatibility.
	Indicates conformity with Australian standards for electromagnetic compatibility.



Safety alerts on this instrument

Additional text may be used with one of the symbols described above when more specific information is needed to avoid exposure to a hazard. See the following table for safety alerts found on the instrument.

Additional text may be used with one of the symbols described above when more specific information is needed to avoid exposure to a hazard. See the following table for safety alerts found on the instrument.

Safety Alerts	
	CAUTION! Hazardous chemicals. Read the Safety Data Sheets (SDSs) before handling.
	CAUTION! Hazardous waste. Refer to SDS(s) and local regulations for handling and disposal.

Location of safety labels on the instrument

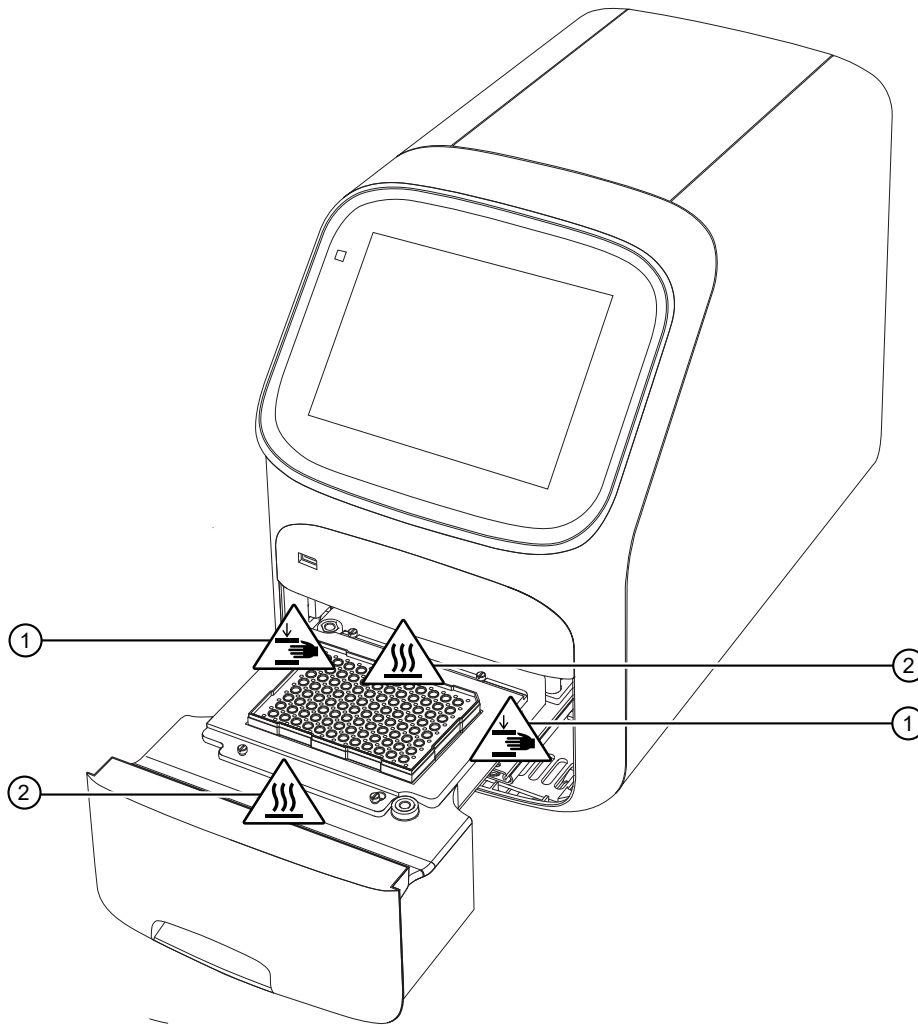

- ① Moving parts
- ② Physical injury hazard



Safety information for instruments not manufactured by Thermo Fisher Scientific

Some of the accessories provided as part of the instrument system are not designed or built by Thermo Fisher Scientific. Consult the manufacturer's documentation for the information needed for the safe use of these products.

Instrument safety

General



CAUTION! Do not remove instrument protective covers. If you remove the protective instrument panels or disable interlock devices, you may be exposed to serious hazards including, but not limited to, severe electrical shock, laser exposure, crushing, or chemical exposure.

Physical injury



CAUTION! Moving Parts. Moving parts can crush, pinch and cut. Keep hands clear of moving parts while operating the instrument. Disconnect power before servicing.



WARNING! Do not attempt to lift or move the instrument without the assistance of others. Use appropriate moving equipment and proper lifting technique, improper lifting may result in serious injury.

Electrical safety



WARNING! Ensure appropriate electrical supply. For safe operation of the instrument:

- Plug the system into a properly grounded receptacle with adequate current capacity.
- Ensure the electrical supply is of suitable voltage.
- Never operate the instrument with the ground disconnected. Grounding continuity is required for safe operation of the instrument.



WARNING! Power Supply Line Cords. Use properly configured and approved line cords for the power supply in your facility.



WARNING! Disconnecting Power. To fully disconnect power either detach or unplug the power cord, positioning the instrument such that the power cord is accessible.

Cleaning and decontamination



CAUTION! Cleaning and Decontamination. Use only the cleaning and decontamination methods specified in the manufacturer's user documentation. It is the responsibility of the operator (or other responsible person) to ensure the following requirements are met:

- No decontamination or cleaning agents are used that could cause a HAZARD as a result of a reaction with parts of the equipment or with material contained in the equipment.
- The instrument is properly decontaminated a) if hazardous material is spilled onto or into the equipment, and/or b) prior to having the instrument serviced at your facility or sending the instrument for repair, maintenance, trade-in, disposal, or termination of a loan (decontamination forms may be requested from customer service).
- Before using any cleaning or decontamination methods (except those recommended by the manufacturer), users should confirm with the manufacturer that the proposed method will not damage the equipment.

Safety and electromagnetic compatibility (EMC) standards

The instrument design and manufacture complies with the following standards and requirements for safety and electromagnetic compatibility.

Safety compliance

Reference	Description
EU Directive 2014/35/EU	European Union "Low Voltage Directive"
IEC 61010-1 EN 61010-1 UL 61010-1 CSA C22.2 No. 61010-1	<i>Safety requirements for electrical equipment for measurement, control, and laboratory use – Part 1: General requirements</i>
IEC 61010-2-010 EN 61010-2-010	<i>Safety requirements for electrical equipment for measurement, control and laboratory use – Part 2-010: Particular requirements for laboratory equipment for the heating of materials</i>
IEC 61010-2-081 EN 61010-2-081	<i>Safety requirements for electrical equipment for measurement, control and laboratory use – Part 2-081: Particular requirements for automatic and semi-automatic laboratory equipment for analysis and other purposes</i>



EMC

Reference	Description
Directive 2014/30/EU	European Union “EMC Directive”
EN 61326-1/ IEC 61326-1	<i>Electrical Equipment for Measurement, Control and Laboratory Use – EMC Requirements – Part 1: General Requirements</i>
AS/NZS CISPR 11	<i>Limits and Methods of Measurement of Electromagnetic Disturbance Characteristics of Industrial, Scientific, and Medical (ISM) Radiofrequency Equipment</i>
ICES-001, Issue 4	<i>Industrial, Scientific and Medical (ISM) Radio Frequency Generators</i>
FCC Part 15 Subpart B (47 CFR)	<i>U.S. Standard Radio Frequency Devices</i>

This equipment has been tested and found to comply with the limits for a Class A digital device, pursuant to part 15 of the FCC Rules. These limits are designed to provide reasonable protection against harmful interference when the equipment is operated in a commercial environment. This equipment generates, uses, and can radiate radio frequency energy and, if not installed and used in accordance with the instruction manual, may cause harmful interference to radio communications. Operation of this equipment in a residential area is likely to cause harmful interference in which case the user will be required to correct the interference at his own expense.

Environmental design

Reference	Description
Directive 2012/19/EU	European Union “WEEE Directive” – Waste electrical and electronic equipment
EU Directive 2011/65/EU & Commission Delegated Directive (EU) 2015/863	European Union “RoHS Directive” – Restriction of hazardous substances in electrical and electronic equipment
Directive 2006/66/EC	European Union “Battery Directive”
GB/T 26572	Requirements of concentration limits for certain restricted substances in electrical and electronic products.

China EEP Hazardous Substances Information						
Component Name	QuantStudio™ 1 Real-Time PCR Instrument (96-Well 0.2-mL Block)					
	Hazardous Substances					
	(Pb)	(Hg)	(Cd)	(Cr(VI))	(PBB)	(PBDE)
PCBA	X	O	O	O	O	O
<p>SJ/T11364. This table is compiled according to SJ/T 11364 standard.</p> <p>O: GB/T26572.</p> <p>Indicates that the concentration of the hazardous substance in all homogeneous materials for the part is below the relevant threshold of the GB/T 26572 standard.</p> <p>X: GB/T26572.</p> <p>Indicates that the concentration of the hazardous substance in at least one homogenous material of the part is above the relevant threshold of the GB/T 26572 standard.</p>						

Chemical safety



WARNING! GENERAL CHEMICAL HANDLING. To minimize hazards, ensure laboratory personnel read and practice the general safety guidelines for chemical usage, storage, and waste provided below. Consult the relevant SDS for specific precautions and instructions:

- Read and understand the Safety Data Sheets (SDSs) provided by the chemical manufacturer before you store, handle, or work with any chemicals or hazardous materials. To obtain SDSs, see the "Documentation and Support" section in this document.
- Minimize contact with chemicals. Wear appropriate personal protective equipment when handling chemicals (for example, safety glasses, gloves, or protective clothing).
- Minimize the inhalation of chemicals. Do not leave chemical containers open. Use only with sufficient ventilation (for example, fume hood).
- Check regularly for chemical leaks or spills. If a leak or spill occurs, follow the manufacturer cleanup procedures as recommended in the SDS.
- Handle chemical wastes in a fume hood.
- Ensure use of primary and secondary waste containers. (A primary waste container holds the immediate waste. A secondary container contains spills or leaks from the primary container. Both containers must be compatible with the waste material and meet federal, state, and local requirements for container storage.)
- After emptying a waste container, seal it with the cap provided.
- Characterize (by analysis if needed) the waste generated by the particular applications, reagents, and substrates used in your laboratory.
- Ensure that the waste is stored, transferred, transported, and disposed of according to all local, state/provincial, and/or national regulations.
- **IMPORTANT!** Radioactive or biohazardous materials may require special handling, and disposal limitations may apply.



WARNING! HAZARDOUS WASTE (from instruments). Waste produced by the instrument is potentially hazardous. Follow the guidelines noted in the preceding General Chemical Handling warning.



WARNING! 4L Reagent and Waste Bottle Safety. Four-liter reagent and waste bottles can crack and leak. Each 4-liter bottle should be secured in a low-density polyethylene safety container with the cover fastened and the handles locked in the upright position.

Biological hazard safety



WARNING! Potential Biohazard. Depending on the samples used on this instrument, the surface may be considered a biohazard. Use appropriate decontamination methods when working with biohazards.



WARNING! BIOHAZARD. Biological samples such as tissues, body fluids, infectious agents, and blood of humans and other animals have the potential to transmit infectious diseases. Conduct all work in properly equipped facilities with the appropriate safety equipment (for example, physical containment devices). Safety equipment can also include items for personal protection, such as gloves, coats, gowns, shoe covers, boots, respirators, face shields, safety glasses, or goggles. Individuals should be trained according to applicable regulatory and company/ institution requirements before working with potentially biohazardous materials. Follow all applicable local, state/provincial, and/or national regulations. The following references provide general guidelines when handling biological samples in laboratory environment.

- U.S. Department of Health and Human Services, *Biosafety in Microbiological and Biomedical Laboratories (BMBL)*, 6th Edition, HHS Publication No. (CDC) 300859, Revised June 2020
<https://www.cdc.gov/labs/pdf/CDC-BiosafetymicrobiologicalBiomedicalLaboratories-2020-P.pdf>
- Laboratory biosafety manual, fourth edition. Geneva: World Health Organization; 2020 (Laboratory biosafety manual, fourth edition and associated monographs)
www.who.int/publications/i/item/9789240011311

Documentation and support

Related documentation

Document	Publication number
<i>QuantStudio™ 1 Real-Time PCR System Installation, Use, and Maintenance Guide</i>	MAN0017853
<i>QuantStudio™ Design and Analysis Desktop Software Command-Line Application Guide</i>	MAN0010409
<i>QuantStudio™ Design and Analysis Desktop Software User Guide</i>	MAN0010408
<i>QuantStudio™ 1 Real-Time PCR System Site Preparation Guide</i>	MAN0017854

Note: For additional documentation, see “Customer and technical support” on page 112.

Obtain information from the Help system

Customer and technical support

Visit thermofisher.com/support for the latest service and support information.

- Worldwide contact telephone numbers
- Product support information
 - Product FAQs
 - Software, patches, and updates
 - Training for many applications and instruments
- Order and web support
- Product documentation
 - User guides, manuals, and protocols
 - Certificates of Analysis
 - Safety Data Sheets (SDSs; also known as MSDSs)

Note: For SDSs for reagents and chemicals from other manufacturers, contact the manufacturer.

Limited product warranty

Life Technologies Corporation and/or its affiliate(s) warrant their products as set forth in the Life Technologies' General Terms and Conditions of Sale at www.thermofisher.com/us/en/home/global/terms-and-conditions.html. If you have any questions, please contact Life Technologies at www.thermofisher.com/support.

Index

A

accessories 100
administrator instrument profile 28
Administrator profile 42

B

background calibration
 create plate 65
 description 58
 plate, prepare 61
Background calibration
 run 62
 when to perform 57
backup instrument 77
barcode scan 51
biohazard safety 111

C

calibration
 reminders 59
 Background 62
 custom dye. *See* custom dye
 custom melt 75
 Dye 62
 plate, prepare 61
 reminders 59
 ROI/Uniformity 62
 schedule 57
 status 59
 transfer results 63
 view images 63
 workflow 60
calibration failure, troubleshoot 64
Change password 46
Change PIN 46
Cloud server, select location 34
comparative Ct experiments 19
computer
 connection to instrument or LAN 17, 88
 connections 85
 set up 87
Connect

Link to instrument 42

Roles

 Administrator 42
 Standard 42
 Unlink from instrument 45
Connect profile, Overview 41
connect to network, workflow 84
connection, not recognized
consumables, 96-well 0.2-mL 99
contamination, identify 64
custom dye
 add to the instrument 73
 calibration plate, create 72
 calibration, perform 73
 description 11
 dilution guidelines 70
 optimal concentration 72
 wavelength requirements 70
custom dye calibration, workflow 70
custom dye dilution plate, prepare 71
custom melt calibration 75

D

data collection points, add to method 52
date and time 34
delete files 25
disk space message
documentation, related 112
dye calibration
 description 58
 plate, prepare 61
Dye calibration
 run 62
 when to perform 57
dyes
 custom 11, 70
 system 10

E

Edit profile 46
EDS files, transfer 25, 56
EDT files, copy or delete 26
Ethernet port 90

experiment
 create from template 48
 edit 50
 run from saved file 48
 run last 49
 experiment types 19

F

factory defaults 36
 firewall ports 90
 fluorescence high
 fuses, replace 81

G

genotyping experiments 19
 guest profile
 disable 39
 limits 28

H

heated cover temperature, set for instrument idling
 33
 Help system, access 112
 home screen, parts of 12

I

Index Term 24, 32–34, 36–39
 installation
 before you begin 85
 workflow 84
 instrument
 profile, create 29
 connections 85
 enable for monitoring 38
 heated cover idle temperature 33
 move 82
 name 33
 overview 10
 parts of 11
 power off 22
 power on 22
 prepare to store or move or ship 82
 return for service 83
 touchscreen black
 instrument filters 10
 instrument layout 94
 instrument settings 30
 instrument specification 94
 instrument verification. *See* RNase P verification

L

language, select 36
 limited product warranty 113
 load plate 23
 Local instrument profile, Overview 41
 lock the touchscreen 56
 log records, view 38

M

maintenance 77
 melt curve experiments 19
 melt curves, add to method 52
 method
 add melt curves 52
 add stages 52
 add steps 52
 data collection points 52
 edit 51
 parts of 52
 pause 54
 ramp rate 54

N

network
 configurations supported 17, 88
 guidelines and best practices 91
 wired connection set up 35
 wireless connection set up 35
 network configuration and security 9
 networking 88

O

online Help. *See* Help system
 Order to set up profiles 41

P

Password, Change 46
 password security 9
 pause run 55
 performance verification. *See* RNase P verification
 PIN, Change 46
 PIN reset 40
 presence/absence experiments 19
 Profile
 Connect
 Link 42
 Unlink 45
 Edit 46
 profiles

- administrator 28
- delete 40
- edit 39
- guest, disable 39
- instrument 29
- require sign-in 39
- reset PIN 40
- sign in 22

Profiles

Connect

- Administrator 42
- Standard 42

- Order to set up 41

- properties, enter or edit 50

- protocol. See method

R

- real-time plots

- view on instrument touchscreen 55
- zoom 55

- related documentation 112

- relative standard curve experiments 19

- Replace with index term

- require sign in 39

- restore instrument 77

- RNase P verification

- pass criteria 67
- plate description 66
- run 68

- RNase P verification, plate, prepare 67

- ROI/uniformity calibration

- description 58
- plate, prepare 61

- ROI/Uniformity calibration

- run 62
- when to perform 57

- run, pause or stop 55

- run data, transfer 25, 56

- run history 25

- run last experiment 49

- run protocol. See method

S

- safety, biohazard 111

- sample block

- clean 78
- decontaminate 78

- settings 30

- sign in, require 39

- sign out

- profile 23
- timer, set 39
- sleep mode 33
- software features 14
- software updates 37
- stages, add to method 52
- standard curve experiments 19
- Standard profile 42
- standby mode 33
- startup wizard 87
- steps, add to method 52
- stop run 55
- support, customer and technical 112
- supported dyes 10
- symbols, safety 102
- system dyes 10

T

- template properties. See properties

- terms and conditions 113

- thermal protocol. See method

- Thermo Fisher Connect profile, Edit 46

- third-party software 17

- transfer files 25

- troubleshooting 92

U

- uniformity calibration

- description 58
- plate, prepare 61

- unload plate 23

- unpack instrument 86

- use the instrument, workflow 47

V

- verification failure, troubleshoot 69

W

- warranty 113

- well details

- define, assign, view 54
- view on instrument touchscreen 55

- workflow, use the instrument 47

Z

- zoom 55

