



# Scout™ Series Balances - SKX Instruction Manual



**Test Equipment  
Depot**  
1-800-517-8431

99 Washington Street  
Melrose, MA 02176  
Phone 781-665-1400  
Toll Free 1-800-517-8431

 Visit us at [www.TestEquipmentDepot.com](http://www.TestEquipmentDepot.com)



# 1. INTRODUCTION

This manual contains installation, operation and maintenance instructions for the Scout SKX Series Balances. Please read the manual completely before using the balance.

## 1.1 Definition of Signal Warnings and Symbols

Safety notes are marked with signal words and warning symbols. These show safety issues and warnings. Ignoring the safety notes may lead to personal injury, damage to the instrument, malfunctions and false results.

### Signal Words

<b>WARNING</b>	For a hazardous situation with medium risk, possibly resulting in injuries or death if not avoided.
<b>CAUTION</b>	For a hazardous situation with low risk, resulting in damage to the device or the property or in loss of data, or injuries if not avoided.
<b>Attention Note</b>	For important information about the product. For useful information about the product.

### Warning Symbols



General Hazard



Electric Shock Hazard

## 1.2 Safety Precautions



**CAUTION:** Read all safety warnings before installing, making connections, or servicing this equipment. Failure to comply with these warnings could result in personal injury and/or property damage. Retain all instructions for future reference.

- Verify that the local AC power supply is within the input voltage range printed on the AC adapter's data label.
- Only connect the AC adapter to a compatible grounded electrical outlet.
- Do not position the scale such that it is difficult to disconnect the AC adapter from the power receptacle.
- Make sure that the power cord does not pose a potential obstacle or tripping hazard.
- This equipment is intended for indoor use and should only be operated in dry locations.
- Operate the equipment only under ambient conditions specified in the user instructions.
- Do not operate the equipment in hazardous or unstable environments.
- Do not drop loads on the pan.
- Only use approved accessories and peripherals.
- Disconnect power from the equipment before cleaning or servicing.
- Service should only be performed by authorized personnel.

# 2. INSTALLATION

## 2.1 Installing Components

Refer to the illustrations and instructions below to identify and assemble your Scout balance with its components. All components must be assembled before using the balance.

### 2.1.1 Releasing the Shipping Lock

Release the red Transportation Lock on the sub-platform of the balance by turning the red pointer 90° counter-clockwise.

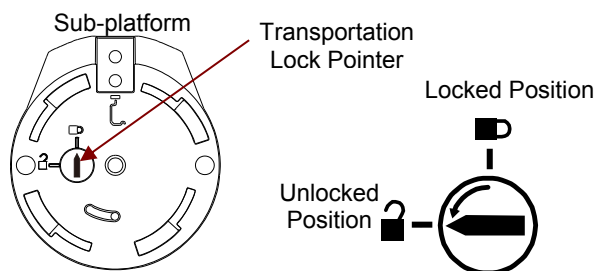

Figure 2-1. Transportation Lock

### 2.1.2 Installing the Weighing Pan

Balances with a rectangular pan are placed into the sub-platform as shown and rotated counter-clockwise until it locks. Round pans are placed straight down on sub-platform.

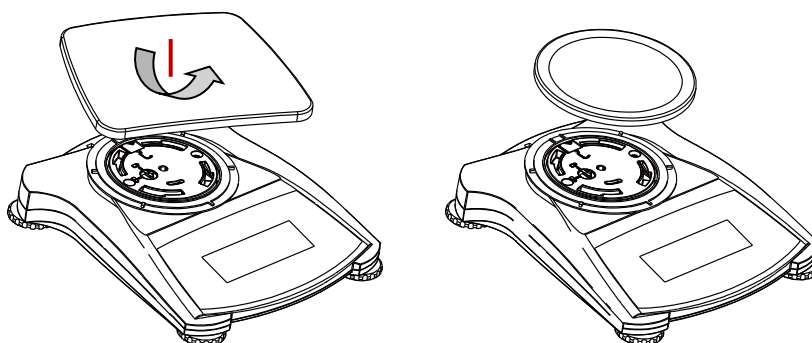

Figure 2-2. Pan Installation

### 2.2.3 Security Slot

A security slot is provided at the rear of the balance allowing the balance to be secured by an optional cable and lock accessory.

## 2.3 Selecting the Location

For best performance, the Scout SKX balance should be used in a clean, stable environment. Do not use the balance in environments with excessive drafts, with rapid temperature changes, near magnetic fields or near equipment that generates magnetic fields, or vibrations.

## 2.4 Connecting Power

### AC Adapter Installation

AC power is used to power the scale when battery power is not needed. First, connect the AC Adapter (supplied) to the AC Adapter Input receptacle at the rear of the balance then connect the AC plug to an electrical outlet.



Figure 2-3. Rear and bottom view of balance

### Battery Installation

Install the four “AA” batteries with polarity as shown in the battery compartment.

#### Note:

After power on, it is recommended to let the balance warm up for at least 5 minutes before using it.

## 2.5 Initial Calibration

When the Balance is first installed, and when it is moved to another location, it must be calibrated to ensure accurate weighing results. The balance can be manually calibrated with external masses. Have the appropriate calibration masses available before beginning calibration. Refer to the Calibration Section for masses and calibration procedure.

## 3. OPERATION

### 3.1 Controls

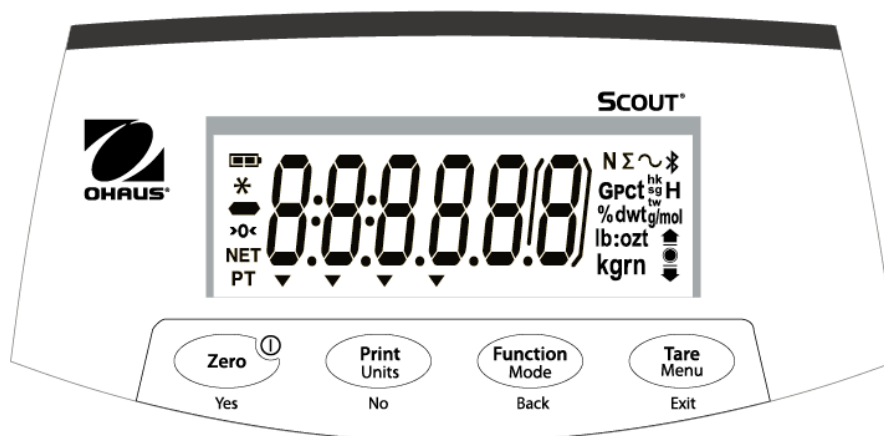

Figure 3-1. Scout Control Panel

TABLE 3-1. Button Functions

Button	Zero <sup>1</sup> Yes	Print Units No	Function Mode Back	Tare Menu Exit
Primary Function (Short Press)	<b>Zero/On</b> Turns the balance on  If balance is On, sets Zero	<b>Print</b> Sends the current value to the selected COM ports if AUTOPRINT is set to Off.	<b>Function</b> Initiates an application mode.	<b>Tare</b> Enter/clear a tare value.
Secondary Function (Long Press)	<b>Zero/Off</b> Turns the balance Off.	<b>Units</b> Changes the weighing unit.	<b>Mode</b> Allows changing the application mode.	<b>Menu</b> Enter the User menu.
Menu Function (Short Press)	<b>Yes</b> Accepts the current setting on the display.	<b>No</b> Advances to the next menu or menu item.  Rejects the current setting on the display and advances to the next available setting.	<b>Back</b> Moves Back to previous menu item.	<b>Exit</b> Exits the User menu.  Aborts the calibration in progress.

**Notes:**

<sup>1</sup> Short Press: Press less than 1 second.

<sup>2</sup> Long Press: Press and hold for more than 2 seconds



Figure 3-2. Scout Display

TABLE 3-2. Display Symbols

Item	Description	Item	Description
1	Battery charge symbol	7	Pointer symbols
2	Stable weight symbol	8	Kilogram, grain symbols
3	Negative symbol	9	Pound, Ounce, Pound:Ounce symbols
4	Center of Zero symbol	10	g/mol symbol
5	NET symbol	11	G symbol
6	Preset Tare symbol	12	Newton, Bluetooth symbols

### 3.2 Turning Balance On/Off

To turn the balance on, press and hold the **On/Zero Off** button for 1 second. The balance performs a display test, momentarily displays the software version, and then enters the active weighing mode.

To turn the balance off, press and hold the **On/Zero Off** button until OFF is displayed.

### 3.3 Calibration Operation

When the balance is operated for the first time, a span calibration is recommended to ensure accurate weighing results. Before performing the calibration, be sure to have the appropriate calibration weights. Ensure that the Security switch is set to unlocked position.

Press and hold Menu until [MENU] (Menu) is displayed. When the button is released, the display will show [C.R.L]. Press **Yes** to accept. [SPAN] will then be shown. Press Yes to begin the span calibration.

[--C--] will be displayed while zero reading is stored. Next, the display shows the calibration weight value (press **No** to toggle value). Place the specified calibration mass on the pan. [--C--] will be displayed while the reading is stored. The display will show [done] if the calibration was successful. The balance returns to the previous application mode and is ready for use.

### 3.4 Weighing Mode

This mode is the factory default setting.

1. If needed, press and hold **Mode** until [WEIGH] (Weigh) is displayed.
2. If required, place an empty container on the pan and press **Tare**.
3. Add sample to the pan or container. The display shows the weight of the sample.

### 3.5 Density Mode

This mode allows the user to calculate the specific gravity of a sample when using the density kit. Density mode has been initiated when “G” and the current unit is displayed.

The sample is weighed in air suspended from the hook and then weighed in water. The formula is

$$\frac{\text{dry weight}}{\text{dry weight} - \text{wet weight}}$$

#### Preparation

Prepare the balance as shown below. Remove the balance pan, insert the hook and install the beaker stand (beaker is not supplied). Then press the **Zero/On** button to turn the balance on.

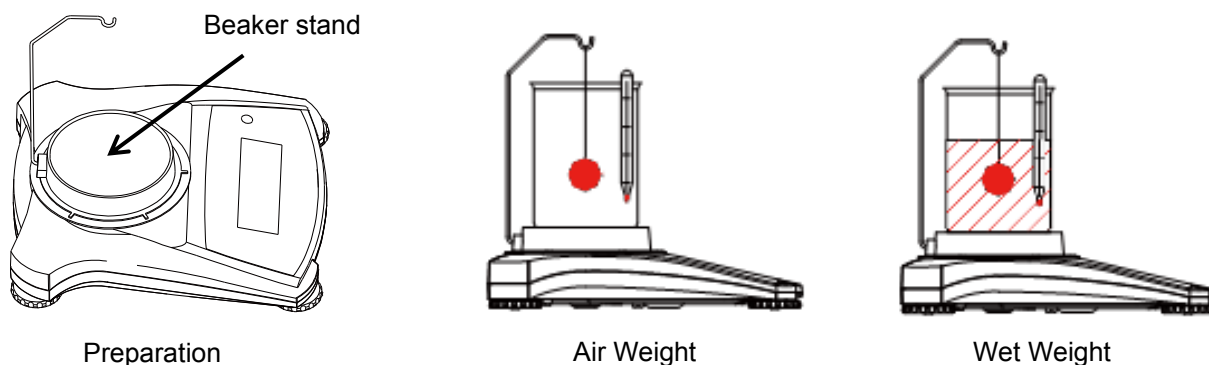

Figure 3-3. Density Setup

#### Density setup

1. Press and hold **Mode** until [SPEC.Gr] is displayed. [A ir. LUt] will then be displayed.
2. Place the sample on the hook as described above and press **Yes** to store the dry weight value. [LJ. LUt] will then be displayed.
3. Suspend the sample in water and press **Yes** to store the wet weight value. The specific gravity value is now displayed and “G” is blinking while the unit icon is turned off.

**Notes:** Specific Gravity has no unit of measure.

For large samples it is recommended to use the weighing below feature instead of the hook.

### 3.6 Mole Weighing Mode

To enter the Mole Weighing mode from any application mode, press and hold the **Mode** key until [Mole] is displayed. When the **Mode** key is released, the display shows [Lr. M].

1. Press the **Yes** key to clear the stored Molar Mass. Press the **No** key to recall the existing Molar Mass. If no Molar Mass was stored, the [Lr. M] display is skipped and inputting a Molar Mass is required.
2. If there is a Molar Mass stored, the current Molar Mass will be displayed and flashing.
3. Press the **No** key to begin editing the Molar Mass.
5. Press the **No** key to increment the flashing digit.
6. Press the **Back** key to decrement the flashing digit.
7. Press the **Yes** key to accept the value and move one digit to the right.

**Notes:** If the setting exceeds the limit, the display returns to the previously stored value.

The most left number can be set to 0, 1, 2, 3, 4, 5, 6, 7, 8, 9, -. All other numbers can be set to 0, 1, 2, 3, 4, 5, 6, 7, 8, 9.

The available settings are from 0.01 to 999.99.

The Molar Mass unit is g/mol.

#### Display Molar Mass:

Press Function key to display the existing Molar Mass value for 2 sec.

#### New Molar Mass:

To enter a new Molar Mass press and hold the Function/Mode key until [Mole] is displayed.







## 4. MENU SETTINGS

The User Menu allows the customizing of balance settings.

Note: Additional Sub-Menus may be available if Interface Options are installed. See Interface User Manual for the additional setting information.

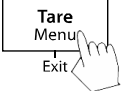
### 4.1 Menu Navigation

#### User Menu:

<u>Sub-Menus</u>	<u>C.a.l</u>	<u>S.e.t.u.p</u>	<u>M.o.d.e</u>	<u>U.n.i.t</u>	<u>E.n.d</u>
<p><i>User Menu Items:</i></p>  <p><b>Long press - Enter menu</b></p>  <p><b>Short press - Accept</b></p>  <p><b>Short press - Go Next/Prev. menu</b></p>  <p><b>Short press - Exit menu</b></p>	<p><i>Span</i></p> <p><i>Lin</i></p> <p><i>End</i></p>	<p><i>Reset</i></p> <p><i>Yes/No</i></p> <p><i>Filter</i></p> <p><i>Low/Med/High</i></p> <p><i>AZT</i></p> <p><i>0.5/1/3/Off</i></p> <p><i>StableRange</i></p> <p><i>0.5/1/2//5</i></p> <p><i>Backlight</i></p> <p><i>Off/On/Auto</i></p> <p><i>Auto Tare</i></p> <p><i>Off/On/On-acc</i></p> <p><i>Auto Off</i></p> <p><i>Off/1/5/10</i></p> <p><i>End</i></p>	<p><i>Reset</i></p> <p><i>Yes/No</i></p> <p><i>Weighing</i></p> <p><i>On/Off</i></p> <p><i>Density</i></p> <p><i>On/Off</i></p> <p><i>Mole</i></p> <p><i>On/Off</i></p> <p><i>End</i></p>	<p><i>Reset</i></p> <p><i>g</i></p> <p><i>kg</i></p> <p><i>N</i></p> <p><i>oz</i></p> <p><i>lb</i></p> <p><i>lb:oz</i></p> <p><i>End</i></p>	

**Notes:** Some Units/Modes may not be available in all models.

When the Security Switch is in locked position, the Calibration function is hidden, Units are locked to the current setting.

#### Security switch:

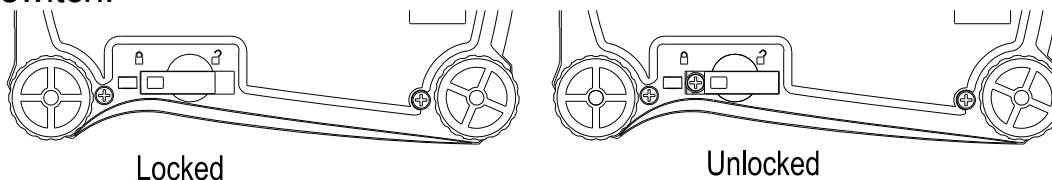

### 4.2 Calibration Menu

Enter this menu to perform calibrations.

Span:	Perform
Linearity:	Perform
End Calibration:	Exit menu

#### Span [SPAN]

Initiates a span calibration procedure (zero and span)

#### Lin [L IN]

Initiates a linearity calibration procedure (zero, mid-point and span).

#### End Cal [END]

Advance to the next menu or return to the top of the current menu.

## 4.3 Setup Menu

Enter this menu to set balance parameters.

Reset:	<b>no</b> , yes
Filter:	Low, <b>Med</b> , High
Auto Zero Tracking:	off, <b>0.5d</b> , 1d, 3d
Stable:	0.5d, <b>1d</b> , 2d, 5d
Backlight:	off, on, <b>auto</b>
Auto Tare:	<b>off</b> , on, on-acc
Auto Off:	<b>off</b> , 1, 5, 10
End Setup:	Exit menu

Note: **Bold** always represents factory default value.

### Reset [rESEt]

Reset the Setup menu to factory defaults.

NO = not reset  
YES = reset

### Filter [F .LEr]

Set the amount of signal filtering.

LOW = less stability, faster stabilization time  
MED = normal stability, stabilization time  
HI = greater stability, slower stabilization time

### AZT [AZt]

Set the automatic zero tracking functionality.

OFF = disabled  
0.5d = the display will maintain zero until a change of 0.5 division per second has been exceeded.  
1d = the display will maintain zero until a change of 1 division per second has been exceeded.  
3d = the display will maintain zero until a change of 3 divisions per second has been exceeded.

### Stable Range [StABLE]

Set the amount the reading can vary while the stability symbol remains on.

0.5d = 0.5 balance division  
1d = 1 balance division  
2d = 2 balance divisions  
5d = 5 balance divisions

### Back Light [b.L .9ht]

Sets backlight functionality.

OFF = always off  
ON = always on  
AUTO = turns on when a button is pressed or the displayed weight changes.

**Note:** When connected with power pack, the backlight is always on.

### Auto Tare [A.tArE]

Set the automatic tare functionality.

OFF = Automatic Tare is disabled  
ON = the first stable gross weight is tared  
ON-ACC = stable gross loads within the accept limits are tared (in Check weighing mode)

**Auto off [A.OFF]**

Set the automatic shut off functionality.

OFF	= disabled
1	= powers off after 1 minute of no activity
5	= powers off after 5 minutes of no activity
10	= powers off after 10 minutes of no activity

**End Setup [End]**

Advance to the next menu or return to the top of the current menu.

**4.4 Mode Menu**

This menu activates modes so they will be available for use with the Mode button.

Reset:	no, yes
Weigh:	off, <b>on</b>
Density:	off, <b>on</b>
Mole:	off, <b>on</b>
End Mode:	Exit menu

**Reset [rESEt]**

Reset the Mode menu to factory defaults.

NO	= not reset
YES	= reset

**Weigh [LWE IGH]**

Set the status.

OFF	= disabled
ON	= enabled

**Density [SPEc.Gr]**

Set the sub-mode

OFF	= disabled
ON	= enabled

**Mole [Mole]**

Set the sub-mode

OFF	= disabled
ON	= enabled

Advance to the next menu or return to the top of the current menu.

**End Mode [End]****4.5 Unit Menu**

This menu activates units so they will be accessible with the **Units** button. The units in the menu must be turned “on” to be active.

Note: Available units vary by model and local regulations.

g:	off, <b>on</b>
kg:	<b>off</b> , on
N:	<b>off</b> , on
oz:	<b>off</b> , on
lb:	<b>off</b> , on
lb:oz:	<b>off</b> , on
End Unit:	Exit menu

## 4.6 Additional Features

### Weigh Below Hook

The Scout Balance is equipped with a weigh below hook for weighing below the balance. The weigh below hook is located at the reverse side of the battery cover as shown below. To use this feature, remove the red protective cover underneath for the weigh below opening.



**Attention:** Before turning the balance over, remove the Pan and Pan Support (if present), and turn the transportation lock to “locked” position to prevent damage.

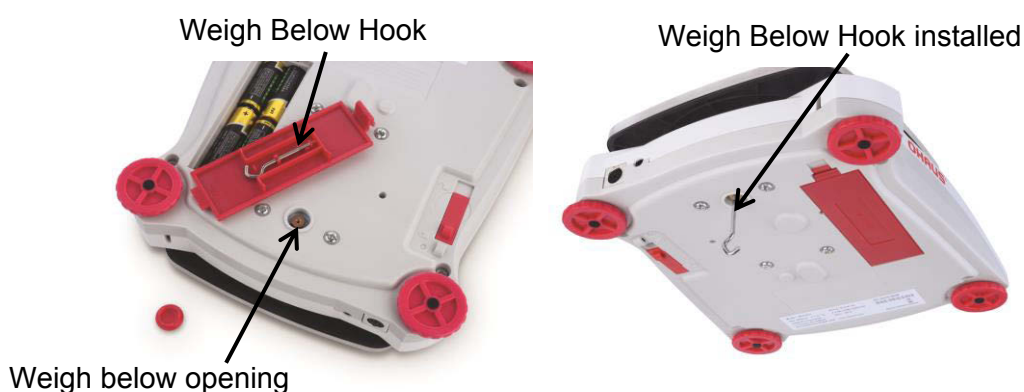

Figure 4-2. Weigh below

The balance can be supported using lab jacks or any other convenient method. Ensure the balance is level and secure and that the transportation lock has been released. Power on the Balance, then use a string or wire to attach items to be weighed.

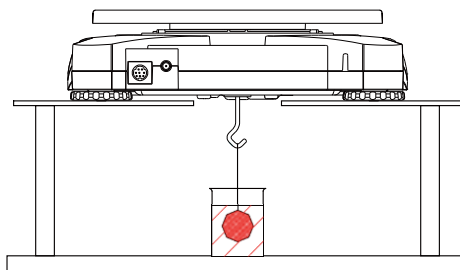

Figure 4-3. Weigh below application

### Connecting the Interface

Use an optional interface connectivity kit to connect the balance either to a computer or a printer.

Below Interface kit accessories are available:  
RS232, USB Host, USB Device, Ethernet,  
Bluetooth®.

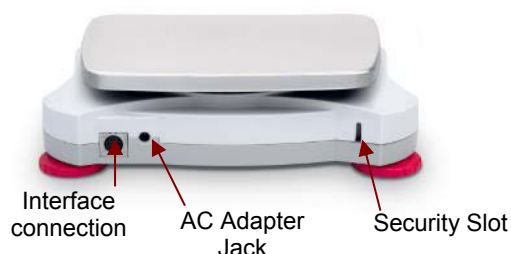

Figure 4-4. Rear of the balance

\* Interface kits may vary according to local regulations

The Bluetooth® word mark and logos are registered trademarks owned by Bluetooth SIG, Inc. and any use of such marks by OHAUS is under license.

## 5. MAINTENANCE

### 5.1 Cleaning



**WARNING:** Electric Shock Hazard. Disconnect the equipment from the power supply before cleaning. Electric Shock Hazard.

The housing may be cleaned with a cloth dampened with a mild detergent if necessary.

**Attention:** Do not use solvents, chemicals, alcohol, ammonia or abrasives to clean the housing or control panel.

### 5.2 Troubleshooting

The following table lists common problems and possible causes and remedies.

If the problem persists, contact OHAUS or your authorized dealer.

TABLE 5-1

Symptom	Possible Cause
Cannot turn on	No power to balance
Poor accuracy	Improper calibration Unstable environment
Cannot calibrate	Security switch in locked position
<b>Err B.1</b>	Weight exceeds power on zero range.
<b>Err B.2</b>	Weight below power on zero range.
<b>Err B.3</b>	Over load (weight exceeds rated capacity)
<b>Err B.4</b>	Under load (pan removed)
<b>Err B.5</b>	Tare out of range
<b>Err B.6</b>	Displayed value exceeds 999999 (possible in Totalization mode)
<b>rEF.Err</b>	Parts counting or percentage error – sample weight <1d. Balance shows error then exits parts counting or goes to <b>[Lr.APL]</b> .
<b>Lo.rEF</b>	Percent Reference weight or APW is too low for accurate results
<b>CAL E</b>	Fail to do calibration.
<b>USb.Err</b>	Cannot find menu or app file in U-disk.

### 5.3 Service Information

If the troubleshooting section does not resolve or describe your problem, contact your authorized OHAUS service agent. For service assistance or technical support in the United States call toll-free 1-800-672-7722 ext. 7852 between 8:00 AM and 5:00 PM EST. An OHAUS product service specialist will be available to provide assistance. Outside the USA, please visit our web site, [www.ohaus.com](http://www.ohaus.com) to locate the OHAUS office nearest you.

## 6. TECHNICAL DATA

The technical data is valid under the following ambient conditions:

Indoor use only

Operating temperature range: +5 °C to +40 °C

Relative humidity: 10% to 80% at 31°C , decreasing linearly to 50% at 40°C, non-condensing

Altitude: Up to 2000 m

Power: AC power adaptor input 100-240V 50/60 Hz and output 5 V DC 1 A, or 4 AA batteries

Pollution degree: 2

Main supply voltage fluctuations: up to ± 10% of the nominal voltage

### 6.1 Specifications

TABLE 6-1. SPECIFICATIONS

Model	SKX123	SKX222	SKX422	SKX622	SKX1202	SKX2202
Capacity (g)	120	220	420	620	1200	2200
Readability (g)	0.001	0.01	0.01	0.01	0.01	0.01
Repeatability (Std. Dev.) (g)	0.002	0.01	0.01	0.01	0.02	0.02
Linearity (g)	0.003	0.01	0.01	0.02	0.03	0.03
Span Calibration Mass*	100 g	200 g	200 g	300 g	1 kg	2 kg
Linearity Calibration Mass	50, 100 g	100, 200 g	200, 400 g	300, 600 g	500 g, 1 kg	1 kg, 2 kg
Stabilization Time (s)	1.5	1	1	1	1.5	1.5
Construction	ABS plastic housing with 304 stainless steel (SST) pan					
Draftshield	Yes	No				
Calibration	User-selectable external span or linearity calibration / Digital with external weight					
Tare Range	Full Capacity by subtraction					
Weighing Units**	g, kg, N, oz, lb, lb:oz					
Application Modes	Weighing, Density Determination, Mole Weighing					
Typical Battery Life	80 hours	120 hours	80 hours			
Specified Temperature Range	10°C (50°F) to 40°C (104°F) at 10% to 80% relative humidity, non-condensing					
Storage Conditions	-20°C (-4°F) to 55°C (131°F) at 10% to 90% relative humidity, non-condensing					
Communication	RS232, USB Host, USB Device, Ethernet or Bluetooth*** (all available as accessory)					
Display Type	Backlit LCD: 6-digit 7-segment with white LED backlight					
Display Size	0.78 in / 20 mm digits					
Pan Size (W x D)	Ø93 mm / 3.7 in	Ø120 mm / 4.7 in			170 x 140 mm / 6.7 x 5.5 in	
Balance Dimensions (W x D x H)	202 x 222 x 103 mm / 8 x 8.7 x 4.1 in	202 x 224 x 54 mm / 8 x 8.8 x 2.1 in				
Shipping Dimensions (W x D x H)	300 x 250 x 129mm / 11.8 x 9.8 x 5.1 in					
Net Weight	1 kg / 2.2 lb					
Shipping Weight	1.6 kg / 3.5 lb					

#### Notes:

\* Calibration weights are included with models up to 620g capacity for certain regions.

\*\* Availability is dependent on model and region.

\*\*\* Bluetooth kit is only available in certain regions according to the local regulations

TABLE 6-2. SPECIFICATIONS (Cont.)

**Capacity x Readability:**

Model	SKX123	SKX222	SKX422	SKX622	SKX1202	SKX2202
Gram (g)	120 x 0.001	220 x 0.01	420 x 0.01	620 x 0.01	1200 x 0.01	2200 x 0.01
Kilogram (kg)	/	/	/	/	1.2 x 0.00001	2.2 x 0.00001
Newton (N)	1.17679 x 0.00001	2.1574 x 0.0001	4.1188 x 0.0001	6.0801 x 0.0001	11.7679 x 0.0001	21.5744 x 0.0001
Ounce (oz)	4.23290 x 0.00005	7.7600 x 0.0005	14.8150 x 0.0005	21.8700 x 0.0005	42.3290 x 0.0005	77.6030 x 0.0005
Pound (lb)	/	/	/	1.36690 x 0.00005	2.64555 x 0.00005	4.85020 x 0.00005
Pound:Ounce (lb:oz)	/	/	/	1lb:5.8700oz x 0.0005oz	2lb:10.3290oz x 0.0005oz	4lb:13.6030oz x 0.0005oz

TABLE 6-3. SPECIFICATIONS (Cont.)

Model	SKX421	SKX621	SKX2201	SKX6201	SKX8200
Capacity (g)	420	620	2200	6200	8200
Readability (g)	0.1	0.1	0.1	0.1	1
Repeatability (Std. Dev.) (g)	0.1	0.1	0.1	0.1	1
Linearity (g)	0.1	0.1	0.1	0.2	1
Span Calibration Mass*	200 g	300 g	2 kg	5 kg	8 kg
Linearity Calibration Mass	200, 400 g	300, 600 g	1 kg, 2 kg	3 kg, 6 kg	4 kg, 8 kg
Stabilization Time (s)	1	1	1	1	1
Construction	ABS plastic housing with 304 stainless steel (SST) pan				
Draftshield	No				
Calibration	User-selectable external span or linearity calibration / Digital with external weight				
Tare Range	Full Capacity by subtraction				
Weighing Units**	g, kg, N, oz, lb, lb:oz				
Application Modes	Weighing, Density Determination, Mole Weighing				
Typical Battery Life	120 hours		80 hours	120 hours	
Specified Temperature Range	10°C (50°F) to 40°C (104°F) at 10% to 80% relative humidity, non-condensing				
Storage Conditions	-20°C (-4°F) to 55°C (131°F) at 10% to 90% relative humidity, non-condensing				
Communication	RS232, USB Host, USB Device, Ethernet or Bluetooth*** (all available as accessory)				
Display Type	Backlit LCD: 6-digit 7-segment with white LED backlight				
Display Size	0.78 in / 20 mm digits				
Pan Size (W x D)	Ø120 mm / 4.7 in	170 x 140 mm / 6.7 x 5.5 in			
Balance Dimensions (W x D x H)	202 x 224 x 54 mm / 8 x 8.8 x 2.1 in				
Shipping Dimensions (W x D x H)	300 x 250 x 129mm / 11.8 x 9.8 x 5.1 in				
Net Weight	1 kg / 2.2 lb				
Shipping Weight	1.6 kg / 3.5 lb				

**Notes:**

\* Calibration weights are included with models up to 620g capacity for certain regions.

\*\* Availability is dependent on model and region.

\*\*\* Bluetooth kit is only available in certain regions according to the local regulation

TABLE 6-4. SPECIFICATIONS (Cont.)

**Capacity x Readability:**

Model	SKX421	SKX621	SKX2201	SKX6201	SKX8200
Gram (g)	420 x 0.1	620 x 0.1	2200 x 0.1	6200 x 0.1	8200 x 1
Kilogram (kg)	/	/	2.2 x 0.0001	6.2 x 0.0001	8.2 x 0.001
Newton (N)	4.119 x 0.001	6.080 x 0.001	21.574 x 0.001	60.801 x 0.001	80.41 x 0.01
Ounce (oz)	14.815 x 0.005	21.870 x 0.005	77.600 x 0.005	218.700 x 0.005	289.25 x 0.05
Pound (lb)	/	1.3670 x 0.0005	4.8500 x 0.0005	13.6685 x 0.0005	18.080 x 0.005
Pound:Ounce (lb:oz)	/	1lb:5.870oz x 0.005oz	4lb:13.600oz x 0.005oz	13lb:10.700oz x 0.005oz	18lb:1.25oz x 0.05oz

### 6.2 Drawings

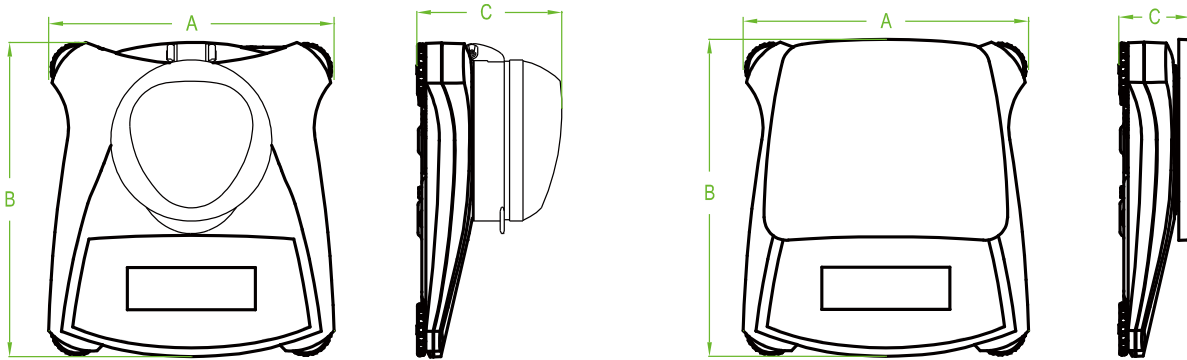

Figure 6.1 Dimensions

Model	A	B	C
with draftshield	202 mm / 8.0 in.	222 mm / 8.7 in.	103 mm / 4.1 in.
w/o draftshield	202 mm / 8.0 in.	224 mm / 8.8 in.	54 mm / 2.1 in.

### 6.3 Compliance

Compliance to the following standards is indicated by the corresponding mark on the product.

Mark	Standard
	This product complies with the applicable harmonized standards of EU Directives 2011/65/EU (RoHS), 2014/30/EU (EMC), 2014/35/EU (LVD) and 2014/31/EU (NAWI). The EU Declaration of Conformity is available online at <a href="http://www.ohaus.com/ce">www.ohaus.com/ce</a> .
	EN 61326-1
	CAN/CSA-C22.2 No. 61010-1 UL Std. No. 61010-1

#### Important notice for verified weighing instruments in the EU

When the instrument is used in trade or a legally controlled application it must be set up, verified and sealed in accordance with local weights and measures regulations. It is the responsibility of the purchaser to ensure that all pertinent legal requirements are met.

Weighing Instruments verified at the place of manufacture bear the following supplementary metrology marking on the descriptive plate.



Weighing Instruments to be verified in two stages have no supplementary metrology marking on the descriptive plate. The second stage of conformity assessment must be carried out by the applicable weights and measures authorities.

If national regulations limit the validity period of the verification, the user of the weighing instrument must strictly observe the re-verification period and inform the weights and measures authorities

As verification requirements vary by jurisdiction, the purchaser should contact their local weights and measures office if they are not familiar with the requirements.

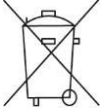

**Disposal**

In conformance with the European Directive 2002/96/EC on Waste Electrical and Electronic Equipment (WEEE) this device may not be disposed of in domestic waste. This also applies to countries outside the EU, per their specific requirements.

Please dispose of this product in accordance with local regulations at the collecting point specified for electrical and electronic equipment. If you have any questions, please contact the responsible authority or the distributor from which you purchased this device.

Should this device be passed on to other parties (for private or professional use), the content of this regulation must also be related.

Disposal instructions in Europe are available online at [www.ohaus.com/weee](http://www.ohaus.com/weee).

Thank you for your contribution to environmental protection.

**FCC Note**

This equipment has been tested and found to comply with the limits for a Class B digital device, pursuant to Part 15 of the FCC Rules. These limits are designed to provide reasonable protection against harmful interference in a residential installation. This equipment generates, uses and can radiate radio frequency energy and, if not installed and used in accordance with the instructions, may cause harmful interference to radio communications. However, there is no guarantee that interference will not occur in a particular installation. If this equipment does cause harmful interference to radio or television reception, which can be determined by turning the equipment off and on, the user is encouraged to try to correct the interference by one or more of the following measures:

- Reorient or relocate the receiving antenna.
- Increase the separation between the equipment and receiver.
- Connect the equipment into an outlet on a circuit different from that to which the receiver is connected.
- Consult the dealer or an experienced radio/TV technician for help.

**Industry Canada Note**

This Class B digital apparatus complies with Canadian ICES-003.

**ISO 9001 Registration**

In 1994, OHAUS Corporation, USA, was awarded a certificate of registration to ISO 9001 by Bureau Veritas Quality International (BVQI), confirming that the OHAUS quality management system is compliant with the ISO 9001 standard's requirements. On June 21, 2012, OHAUS Corporation, USA, was re-registered to the ISO 9001:2008 standard.

### LIMITED WARRANTY

OHAUS products are warranted against defects in materials and workmanship from the date of delivery through the duration of the warranty period. During the warranty period OHAUS will repair, or, at its option, replace any component(s) that proves to be defective at no charge, provided that the product is returned, freight prepaid, to OHAUS. This warranty does not apply if the product has been damaged by accident or misuse, exposed to radioactive or corrosive materials, has foreign material penetrating to the inside of the product, or as a result of service or modification by other than OHAUS. In lieu of a properly returned warranty registration card, the warranty period shall begin on the date of shipment to the authorized dealer. No other express or implied warranty is given by OHAUS Corporation. OHAUS Corporation shall not be liable for any consequential damages.

As warranty legislation differs from state to state and country to country, please contact OHAUS or your local OHAUS dealer for further details.



99 Washington Street  
Melrose, MA 02176  
Phone 781-665-1400  
Toll Free 1-800-517-8431

 Visit us at [www.TestEquipmentDepot.com](http://www.TestEquipmentDepot.com)



\* 3 0 2 6 9 0 3 9 \*

P/N 30269039 D © 2017 OHAUS Corporation, all rights reserved

Printed in China